

zehnder

Rittling

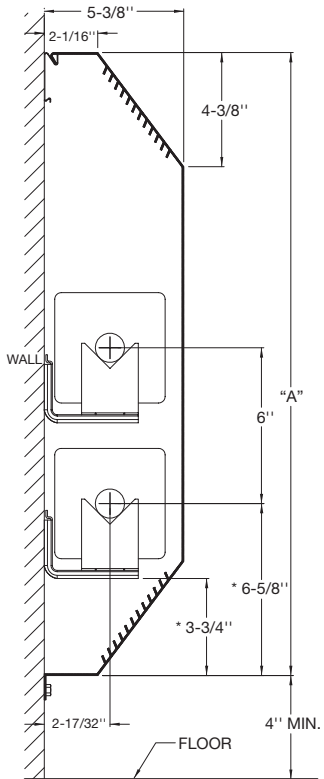

* CENTERLINES ARE BASED ON 1" COPPER TUBE

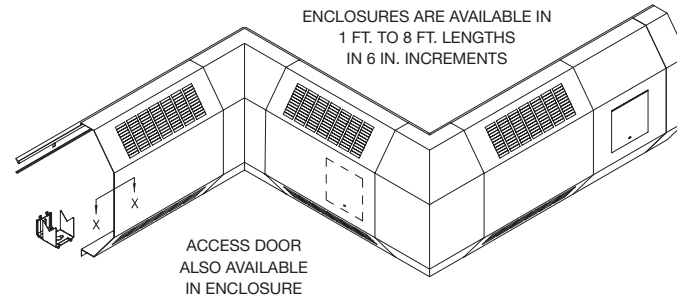
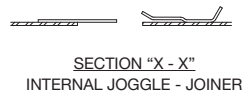
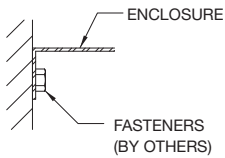
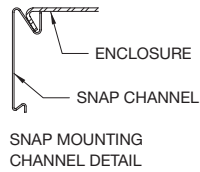

ACCESSORIES

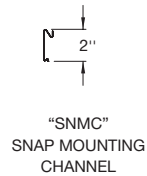
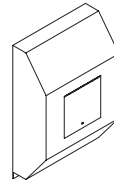

"SLSRB"
SLIP - IN SECOND ROW BRACKET



"WPH"
WALL PIPE HANGER

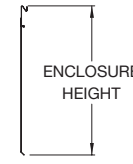

"SNFBP"
SNAP FULL BACK PANEL

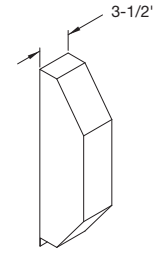

"EC"
END CAP (LEFT HAND SHOWN)

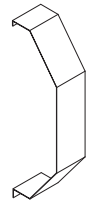

"WT"
WALL TRIM STRIP
3-1/2", 5", 7-1/2"

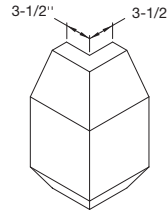

"OC"
OUTSIDE CORNER

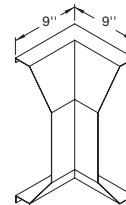

"IC"
INSIDE CORNER

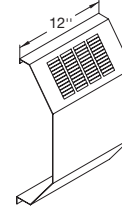

"AS"
REMOVABLE ENCLOSURE SECTION
BUTT TYPE STYLE ONLY
NO JOGGLES OR JOINERS

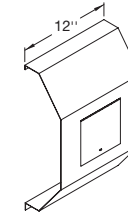

"AP"
ACCESS PANEL WITH ACCESS DOOR,
(SECURITY LOCK OPT.)

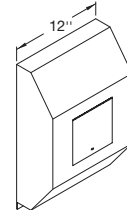

"AC"
END CAP WITH ACCESS DOOR,
LEFT SIDE SHOWN
(SECURITY LOCK OPT.)

DOOR
6" x 6"

DOOR
6" x 6"



"WS"
WALL TRIM SUPPORT



KNOB DAMPER



SECURITY DAMPER

NOTE:
1) ALL ACCESSORIES OVERLAP (EXCEPT AS NOTED)
2) BUTT TYPE (INTERLOCKING) STYLE OPTIONAL (EXCEPT AS NOTED)



MODEL	PIPE SIZE		FIN SIZE	A
	STEEL	COPPER		
FSOS5	N/A	3/4", 1", 1-1/4"	2-3/4" x 4"	18"
	1", 1-1/4"	3/4", 1", 1-1/4"	3-1/4", x 3-1/4"	
	1", 1-1/4", 2"	3/4", 1", 1-1/4"	4-1/4" x 4-1/4"	24"

CONTRACTOR _____ ELEMENT _____

ARCHITECT _____ RATING _____ BTU _____ A.W.T. _____ E.A.T. _____

ENGINEER _____ BACKPLATE _____ FULL _____ PARTIAL _____

REPRESENTATIVE _____ ENCL. GAUGE _____ MATERIAL _____

LOCATION _____ COLOR _____ DAMPER _____

ZEHNDER RITTLING
100 RITTLING BLVD. • BUFFALO, NY USA 14220

JOB:

ENCLOSURE MODEL: **FSOS5**

DATE: **January 2011**

DWG.NO.: **FSOS5**