

Rittling Cabinet Unit Heater Submittal Data

Model: RCW-400-Recessed

Dimensions and Data

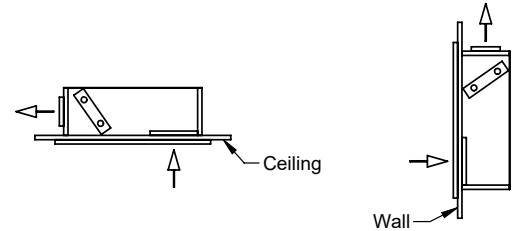
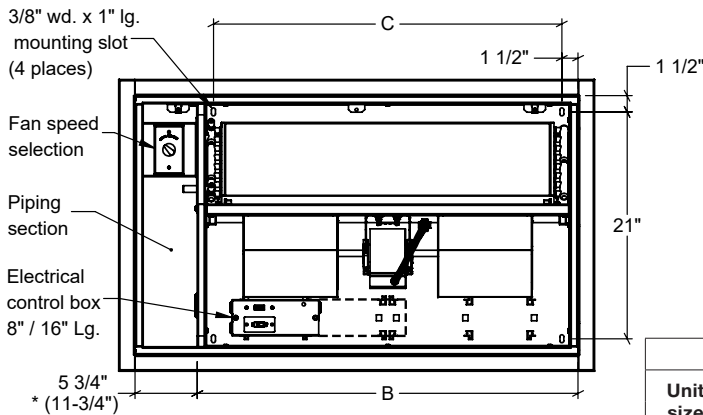
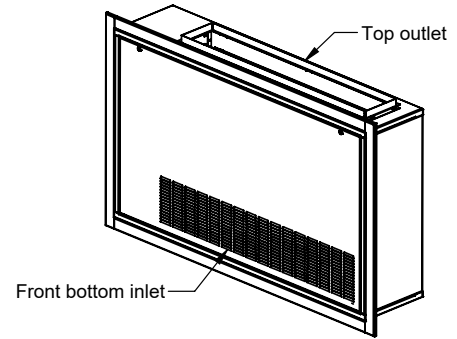
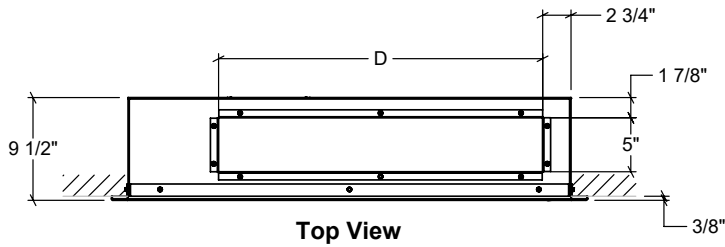

Front View
(less front panel)

* Optional end pocket extension

Unit size	Dimensional Data							
	A		B	C	Louvres		**Bargrille	
	Std.	*6" Ext			D	E	D	E
10	67	73	61-1/4	58-1/4	58	6	56	5

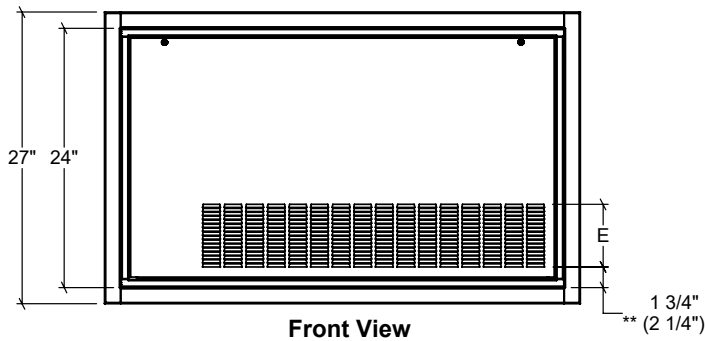

Front View

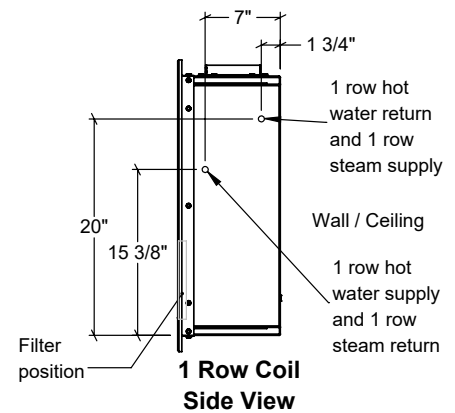

1 Row Coil Side View

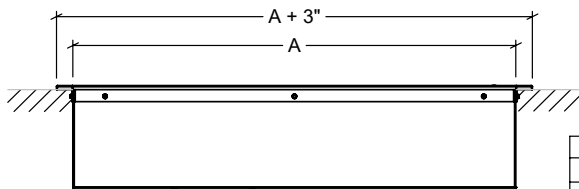

Bottom View

Dimensional data			
Coil	E	F	G
2 Row	17-5/8	18-3/8	4-3/8
4 Row	17-7/8	19-1/8	3-1/4

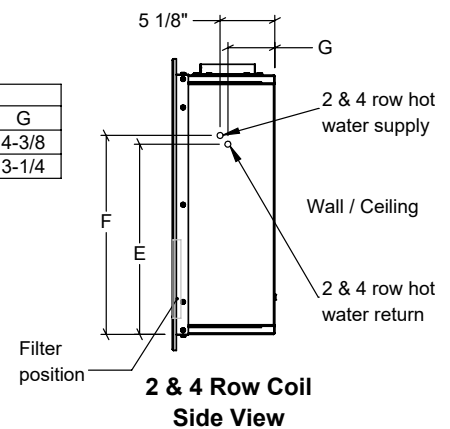

2 & 4 Row Coil Side View

Notes:

- 1, 2, and 4 row coil supply and return connections are 1/2" nominal (5/8" OD) on all sizes
- Unit shown with left hand piping connections
- Right hand piping connections available as an option
- Piping hand determined when facing the air outlet
- All listed dimensions are approximate and are subject to change without notice
- Modifications to the product specifications must be accepted by Zehnder at its base office
- See www.zehnder-rittling.com for any recent updates or changes