

Rittling Cabinet Unit Heater

Submittal Data

Model: RFF-200

Dimensions and Data

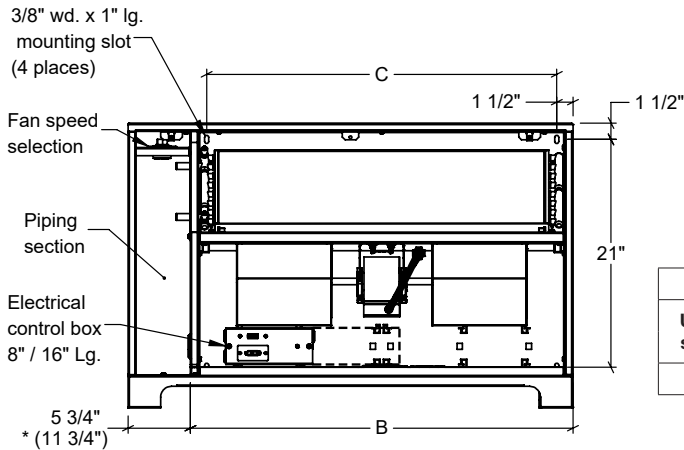
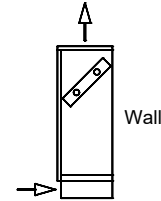
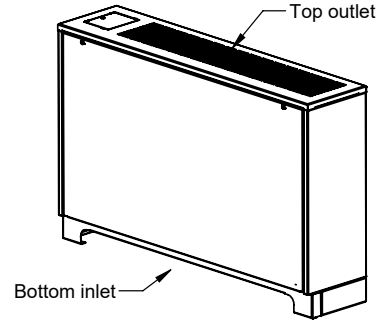
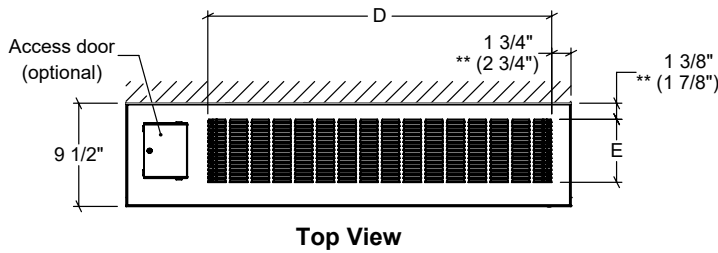

Unit size	Dimensional Data							
	A		B	C	Louvres		**Bargrille	
	Std.	*6" Ext			D	E	D	E
04	41	47	35-1/4	32-1/4	32	6	30	5

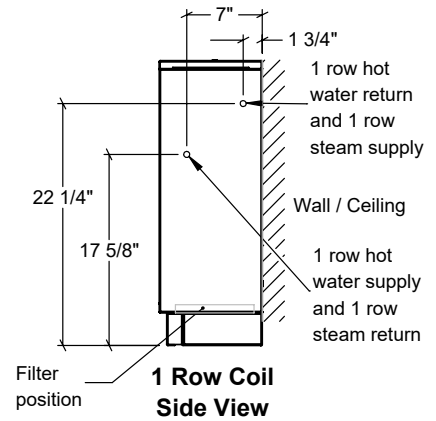
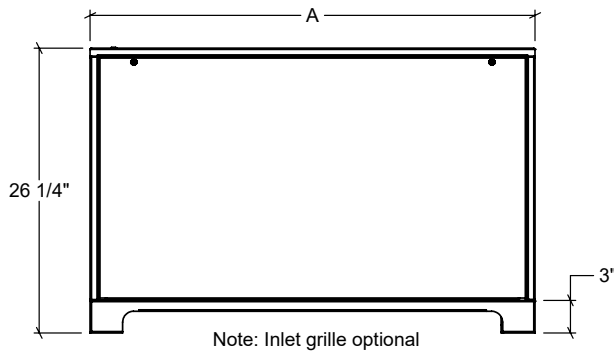

Dimensional data			
Coil	E	F	G
2 Row	19-7/8	20-5/8	4-3/8
4 Row	20-1/8	21-3/8	3-1/4

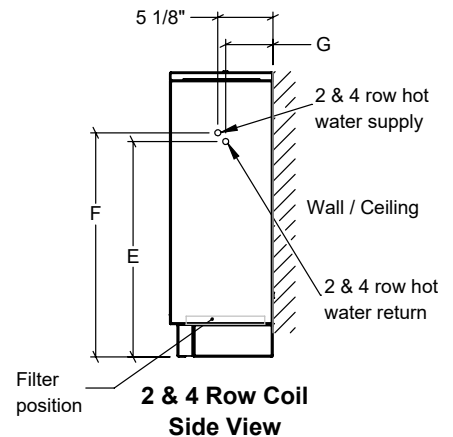

Notes:

- 1, 2, and 4 row coil supply and return connections are 1/2" nominal (5/8" OD) on all sizes
- Inlet grille optional
- Unit shown with left hand piping connections
- Right hand piping connections available as an option
- Piping hand determined when facing the air outlet
- All listed dimensions are approximate and are subject to change without notice
- Modifications to the product specifications must be accepted by Zehnder at its base office
- See www.zehnder-rittling.com for any recent updates or changes