

Rittling Security Enclosures

Submittal Data,
English Language, IP Units

Submittal data

Project
Job number
Architect
Engineer
Contractor

Performance data: heating

Mean water temperature	°F
Design room temperature	°F
Heating capacity	BTU/hr ft

Performance data: cooling

Mean water temperature	°F
Design room temperature	°F
Cooling capacity	BTU/hr ft ²

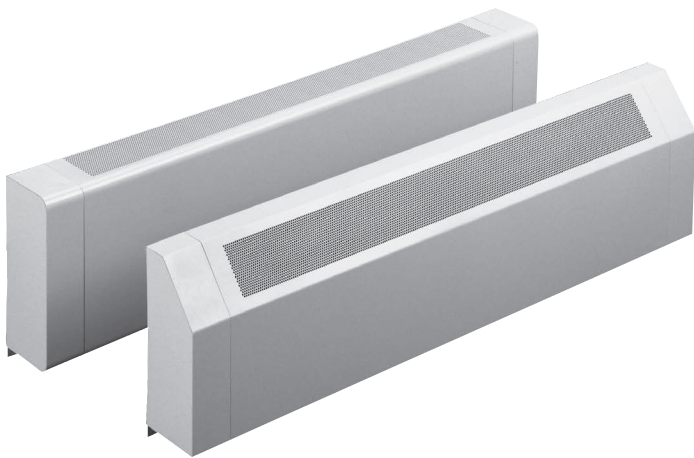

Table of contents	*Page number
Unit features	1
General data	2
Dimensional data	50
Accessories	52
Mechanical specifications	56
Warranty	58

Revised February 2016. Zehnder periodically makes changes to the design and/or specifications of its products. As a result, the design and specifications of each product at the time of order may be different than as described herein. Please contact Zehnder's Sales Support staff at 844-934-6337 for specific information on current design and specifications. Designs, specifications and other information contained herein are not express warranties, which are only as expressly set forth by Zehnder in its terms and conditions of sale. The latest version of this document is available at www.zehnder-ritting.com.

Features

Enclosures

- 8 security models in pattern strip perforation or fully perforated styles
- 1 louvered style (S-SL)
- Perforation is standard 1/8" diameter holes on 3/16" staggered centerlines. Other perforation styles.
- 12-, 14- or 16-gauge, phosphatized cold rolled steel (perforated)
- 14-, 16- or 18-gauge, phosphatized cold rolled steel (S-SL)
- Powder coating finish available in standard or decorator colors
- 1' to 8' lengths in 6" increments
- Stainless steel available

Copper/Aluminum Element

- Tube: 3/4", 1" or 1-1/4"
- Fin: 2-3/4" x 4", 3-1/4" x 3-1/4" or 4-1/4" x 4-1/4"
- 1' to 12' lengths in 6" increments

Steel Element

- Tube: 1", 1-1/4" or 2"
- Fin: 3-1/4" x 3-1/4" or 4-1/4" x 4-1/4"
- 1-1/2' to 10' length in 6" increments

Mounting

- Off-set mounting channel (standard)
- Off-set full back panel; 14-, 16- or 18-gauge galvanized steel (perforated enclosures) and 18- or 20-gauge galvanized steel (S-SL)
- Urethane gasket for air seal available
- 5/16" mounting holes in bottom flange of enclosure
- 4' or 8' lengths

Hangers

- Wall mounted second row brackets used for mounting all rows of element
- 16-GA galvanized steel
- Slide cradle will accommodate 1-3/4-inch linear expansion for quiet operation
- Wall pipe hanger for use with bare tube supply and return pipes.

Joints

- Internal joggle joiners provide hairline joints without any external fasteners

Damper (optional, partial perforated only)

- Tamper-proof, allen tool operated with exclusive "Anti-Slip" damper rod
- Durable knob option available for S-SL only (non-security)

Accessories

- Standard accessories are 18-gauge
- 14- and 16-gauge are available
- Overlap for telescoping fit
- Optional butt fit available

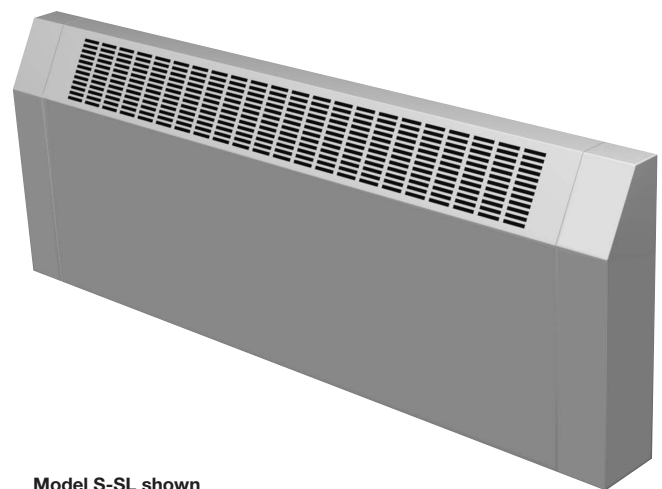

Model S-SL shown

Enclosure Submittal Data

English, IP Units

General data

Performance ratings: model S-SP5/PS5; perforated enclosure

In BTU/hr per active (finned) lineal foot of tube at entering air temperature of 65°F

Element	Rows of element (on 6-inch centers)	Enclosure height (in inches)	Recommended minimum installed height (in inches)	EDR* (ft ² /ft)	Steam heat	Hot water heat				
					215°F factor of 1.00	190°F factor of 0.78	180°F factor of 0.69	170°F factor of 0.61	160°F factor of 0.53	
Steel element										
1" Dia. steel	1S-3¼ X 3¼-32	1	12	16	3.6	867	676	598	529	460
		1	18	22	3.8	905	706	624	552	480
		2	18	22	5.6	1351	1054	933	824	716
		1	24	28	3.9	942	735	650	575	500
		2	24	28	5.9	1408	1098	971	859	746
		3	24	28	6.6	1582	1234	1091	965	838
	1S-3¼ X 3¼-40	1	12	16	4.0	964	752	665	588	511
		1	18	22	4.3	1038	810	716	633	550
		2	18	22	6.3	1523	1188	1051	929	807
		1	24	28	4.5	1075	839	742	656	570
		2	24	28	6.7	1600	1248	1104	976	848
		3	24	28	9.5	2274	1774	1569	1387	1205
	1S-3¼ X 3¼-48	1	12	16	4.4	1067	832	736	651	565
		1	18	22	5.1	1214	947	838	741	643
		2	18	22	7.3	1746	1362	1205	1065	925
		1	24	28	5.2	1251	976	863	763	663
		2	24	28	7.4	1786	1393	1232	1089	947
		3	24	28	9.0	2163	1687	1493	1320	1147
1" Dia. steel	1S-4¼ X 4¼-32	1	12	16	4.6	1115	870	769	680	591
		1	18	22	4.8	1164	908	803	710	617
		2	18	22	7.3	1745	1361	1204	1065	925
		1	24	28	5.1	1212	945	836	739	642
		2	24	28	7.6	1818	1418	1254	1109	964
		3	24	28	8.7	2085	1626	1438	1272	1105
	1S-4¼ X 4¼-40	1	12	16	5.3	1260	983	870	769	668
		1	18	22	5.7	1357	1059	937	828	719
		2	18	22	8.0	1915	1494	1321	1168	1015
		1	24	28	5.9	1406	1097	970	858	745
		2	24	28	8.4	2012	1569	1388	1227	1066
		3	24	28	11.6	2788	2174	1923	1700	1477
	1S-4¼ X 4¼-48	1	12	16	5.9	1406	1097	970	858	745
		1	18	22	6.7	1600	1248	1104	976	848
		2	18	22	8.9	2133	1664	1472	1301	1131
		1	24	28	6.9	1648	1286	1137	1005	874
		2	24	28	9.1	2182	1702	1505	1331	1156
		3	24	28	10.5	2521	1966	1739	1538	1336

*EDR - Equivalent Direct Radiation area (for steam heat) per active (finned) lineal foot of tube.

Important rating information Performance ratings based on:

- Installation at height shown. (Lower heights are not recommended; for greater heights refer to EZselect selection software).
- Entering air temperature of 65°F. (For other temperatures, refer to EZselect selection software).

- Steam at nominal 1 (actual 0.9) psig and 215°F. (For other conditions, refer to EZselect selection software).
- Water average temperature (°F) shown and velocity of 3 fps or more. (For lower velocities, refer to EZselect selection software).

Revised February 2016. Zehnder periodically makes changes to the design and/or specifications of its products. As a result, the design and specifications of each product at the time of order may be different than as described herein. Please contact Zehnder's Sales Support staff at 844-934-6337 for specific information on current design and specifications. Designs, specifications and other information contained herein are not express warranties, which are only as expressly set forth by Zehnder in its terms and conditions of sale. The latest version of this document is available at www.zehnder-ritting.com.

Enclosure Submittal Data

English, IP Units

General data

Performance ratings: model S-SP5/PS5; perforated enclosure

In BTU/hr per active (finned) lineal foot of tube at entering air temperature of 65°F

Element	Rows of element (on 6-inch centers)	Enclosure height (in inches)	Recommended minimum installed height (in inches)	EDR* (ft ² /ft)	Steam heat	Hot water heat				
					215°F factor of 1.00	190°F factor of 0.78	180°F factor of 0.69	170°F factor of 0.61	160°F factor of 0.53	
Steel element										
1 1/4" Dia. steel	1 1/4S-3 1/4 X 3 1/4-32	1	12	16	3.5	850	663	587	519	451
		1	18	22	3.7	887	692	612	541	470
		2	18	22	5.7	1365	1065	942	833	724
		1	24	28	3.9	924	721	638	564	490
		2	24	28	5.9	1422	1109	981	867	754
		3	24	28	6.8	1631	1272	1125	995	864
	1 1/4S-3 1/4 X 3 1/4-40	1	12	16	3.9	936	730	646	571	496
		1	18	22	4.2	1008	786	696	615	534
		2	18	22	6.2	1479	1154	1020	902	784
		1	24	28	4.4	1044	814	720	637	553
		2	24	28	6.5	1554	1212	1072	948	823
	1 1/4S-3 1/4 X 3 1/4-48	1	12	16	4.2	1016	793	701	620	539
		1	18	22	4.8	1156	902	798	705	613
		2	18	22	6.9	1647	1285	1137	1005	873
		1	24	28	5.0	1191	929	822	727	631
		2	24	28	7.0	1685	1314	1163	1028	893
		3	24	28	8.4	2022	1577	1395	1233	1072
	1 1/4" Dia. steel	1 1/4S-4 1/4 X 4 1/4-32	1	12	16	4.6	1110	870	770	680
1			18	22	4.8	1150	890	790	700	610
2			18	22	7.2	1730	1350	1190	1060	920
1			24	28	5	1190	930	820	730	630
2			24	28	7.5	1810	1410	1250	1100	960
3			24	28	8.6	2070	1610	1430	1260	1100
1 1/4S-4 1/4 X 4 1/4-40		1	12	16	5.2	1250	980	860	760	660
		1	18	22	5.6	1340	1050	920	820	710
		2	18	22	7.9	1900	1480	1310	1160	1010
		1	24	28	5.8	1380	1080	950	840	730
		2	24	28	8.3	1980	1540	1370	1210	1050
1 1/4S-4 1/4 X 4 1/4-48		1	12	16	5.8	1400	1090	970	850	740
		1	18	22	6.6	1580	1230	1090	960	840
		2	18	22	8.8	2100	1640	1450	1280	1110
		1	24	28	6.8	1620	1260	1120	990	860
		2	24	28	9	2170	1690	1500	1320	1150
		3	24	28	10.4	2500	1950	1730	1530	1330

*EDR - Equivalent Direct Radiation area (for steam heat) per active (finned) lineal foot of tube.

Important rating information Performance ratings based on:

- Installation at height shown. (Lower heights are not recommended; for greater heights refer to EZselect selection software).
- Entering air temperature of 65°F. (For other temperatures, refer to EZselect selection software).

- Steam at nominal 1 (actual 0.9) psig and 215°F. (For other conditions, refer to EZselect selection software).
- Water average temperature (°F) shown and velocity of 3 fps or more. (For lower velocities, refer to EZselect selection software).

Revised February 2016. Zehnder periodically makes changes to the design and/or specifications of its products. As a result, the design and specifications of each product at the time of order may be different than as described herein. Please contact Zehnder's Sales Support staff at 844-934-6337 for specific information on current design and specifications. Designs, specifications and other information contained herein are not express warranties, which are only as expressly set forth by Zehnder in its terms and conditions of sale. The latest version of this document is available at www.zehnder-ritting.com.

Enclosure Submittal Data

English, IP Units

General data

Performance ratings: model S-SP5/PS5; perforated enclosure

In BTU/hr per active (finned) lineal foot of tube at entering air temperature of 65°F

Element	Rows of element (on 6-inch centers)	Enclosure height (in inches)	Recommended minimum installed height (in inches)	EDR* (ft ² /ft)	Steam heat	Hot water heat				
					215°F factor of 1.00	190°F factor of 0.78	180°F factor of 0.69	170°F factor of 0.61	160°F factor of 0.53	
Steel element										
2" Dia. steel	2S-4 ¹ / ₄ X 4 ¹ / ₄ -32	1	12	16	4.4	1060	827	731	647	562
		1	18	22	4.6	1106	863	763	675	586
		2	18	22	7.0	1676	1307	1157	1022	888
		1	24	28	4.8	1152	899	795	703	611
		2	24	28	7.3	1746	1362	1205	1065	925
		3	24	28	8.3	2002	1562	1381	1221	1061
	2S-4 ¹ / ₄ X 4 ¹ / ₄ -40	1	12	16	5.0	1211	944	835	738	642
		1	18	22	5.4	1304	1017	900	795	691
		2	18	22	7.6	1820	1420	1256	1110	965
		1	24	28	5.6	1350	1053	932	824	716
		2	24	28	8.0	1912	1492	1320	1167	1014
		3	24	28	10.9	2622	2045	1809	1599	1390
	2S-4 ¹ / ₄ X 4 ¹ / ₄ -48	1	12	16	5.6	1350	1053	932	824	716
		1	18	22	6.4	1536	1198	1060	937	814
		2	18	22	8.4	2006	1565	1384	1224	1063
		1	24	28	6.6	1583	1235	1092	966	839
		2	24	28	8.6	2052	1601	1416	1252	1088
		3	24	28	9.8	2346	1830	1619	1431	1244

*EDR - Equivalent Direct Radiation area (for steam heat) per active (finned) lineal foot of tube.

Important rating information Performance ratings based on:

- Installation at height shown. (Lower heights are not recommended; for greater heights refer to EZselect selection software).
- Entering air temperature of 65°F. (For other temperatures, refer to EZselect selection software).

- Steam at nominal 1 (actual 0.9) psig and 215°F. (For other conditions, refer to EZselect selection software).
- Water average temperature (°F) shown and velocity of 3 fps or more. (For lower velocities, refer to EZselect selection software).

Enclosure Submittal Data

English, IP Units

General data

Performance ratings: model S-SP5/PS5; perforated enclosure

In BTU/hr per active (finned) lineal foot of tube at entering air temperature of 65°F

Element	Rows of element (on 6-inch centers)	Enclosure height (in inches)	Recommended minimum installed height (in inches)	EDR* (ft ² / ft)	Steam heat	Hot water heat				
					215°F factor of 1.00	190°F factor of 0.78	180°F factor of 0.69	170°F factor of 0.61	160°F factor of 0.53	
Copper element										
3/4" Dia. copper	3/4C-23/4 X 4-32	1	12	16	4.4	1056	824	729	644	560
		1	18	22	4.6	1114	869	768	679	590
		2	18	22	7.3	1754	1368	1211	1070	930
		1	24	28	5.0	1190	929	821	726	631
		2	24	28	8.3	1981	1546	1367	1209	1050
		3	24	28	9.7	2323	1812	1603	1417	1231
	3/4C-23/4 X 4-40	1	12	16	5.2	1260	982	869	768	668
		1	18	22	5.7	1358	1059	937	828	720
		2	18	22	8.3	1986	1549	1371	1212	1053
		1	24	28	6.2	1476	1151	1018	900	782
		2	24	28	9.3	2221	1733	1533	1355	1177
		3	24	28	11.0	2650	2067	1828	1616	1404
	3/4C-23/4 X 4-48	1	12	16	5.5	1319	1028	910	804	699
		1	18	22	6.3	1515	1182	1046	924	803
		2	18	22	8.2	1965	1533	1356	1199	1042
		1	24	28	7.1	1692	1320	1168	1032	897
		2	24	28	10.3	2473	1929	1706	1509	1311
		3	24	28	12.6	3026	2361	2088	1846	1604
3/4" Dia. copper	3/4C-31/4 X 31/4-32	1	12	16	4.1	990	772	683	604	525
		1	18	22	4.4	1044	814	720	637	553
		2	18	22	6.7	1612	1257	1112	983	854
		1	24	28	4.7	1116	870	770	681	591
		2	24	28	7.6	1820	1420	1256	1110	965
		3	24	28	8.8	2112	1647	1457	1288	1119
	3/4C-31/4 X 31/4-40	1	12	16	4.8	1152	899	795	703	611
		1	18	22	5.2	1242	969	857	758	658
		2	18	22	7.4	1786	1393	1232	1089	946
		1	24	28	5.6	1350	1053	932	824	716
		2	24	28	8.3	1997	1558	1378	1218	1058
		3	24	28	9.8	2362	1842	1630	1441	1252
	3/4C-31/4 X 31/4-48	1	12	16	5.0	1206	941	832	736	639
		1	18	22	5.8	1386	1081	956	845	735
		2	18	22	7.2	1730	1350	1194	1055	917
		1	24	28	6.5	1548	1207	1068	944	820
		2	24	28	9.1	2177	1698	1502	1328	1154
		3	24	28	10.9	2621	2044	1808	1599	1389

*EDR - Equivalent Direct Radiation area (for steam heat) per active (finned) lineal foot of tube.

Important rating information Performance ratings based on:

- Installation at height shown. (Lower heights are not recommended; for greater heights refer to EZselect selection software).
- Entering air temperature of 65°F. (For other temperatures, refer to EZselect selection software).

- Steam at nominal 1 (actual 0.9) psig and 215°F. (For other conditions, refer to EZselect selection software).
- Water average temperature (°F) shown and velocity of 3 fps or more. (For lower velocities, refer to EZselect selection software).

Revised February 2016. Zehnder periodically makes changes to the design and/or specifications of its products. As a result, the design and specifications of each product at the time of order may be different than as described herein. Please contact Zehnder's Sales Support staff at 844-934-6337 for specific information on current design and specifications. Designs, specifications and other information contained herein are not express warranties, which are only as expressly set forth by Zehnder in its terms and conditions of sale. The latest version of this document is available at www.zehnder-ritting.com.

Enclosure Submittal Data

English, IP Units

General data

Performance ratings: model S-SP5/PS5; perforated enclosure

In BTU/hr per active (finned) lineal foot of tube at entering air temperature of 65°F

Element	Rows of element (on 6-inch centers)	Enclosure height (in inches)	Recommended minimum installed height (in inches)	EDR* (ft ² /ft)	Steam heat	Hot water heat				
					215°F factor of 1.00	190°F factor of 0.78	180°F factor of 0.69	170°F factor of 0.61	160°F factor of 0.53	
Copper element										
3/4" Dia. copper	3/4C-4 1/4 X 4 1/4-32	1	12	16	5.5	1310	1020	900	800	690
		1	18	22	5.8	1390	1080	960	850	740
		2	18	22	8.5	2050	1600	1410	1250	1090
		1	24	28	6.2	1480	1150	1020	900	780
		2	24	28	9.6	2310	1800	1590	1410	1220
		3	24	28	11	2640	2060	1820	1610	1400
	3/4C-4 1/4 X 4 1/4-40	1	12	16	6.4	1350	1190	1060	930	810
		1	18	22	6.9	1660	1290	1150	1010	880
		2	18	22	9.3	2170	1730	1530	1350	1180
		1	24	28	7.5	1790	1400	1240	1090	950
		2	24	28	10.4	2490	1940	1720	1520	1320
		3	24	28	12	2870	2240	1980	1750	1520
	3/4C-4 1/4 X 4 1/4-48	1	12	16	6.7	1610	1260	1110	980	850
		1	18	22	7.7	1850	1440	1280	1130	980
		2	18	22	8.9	2130	1660	1470	1300	1130
		1	24	28	8.6	2070	1610	1430	1260	1100
		2	24	28	11.2	2690	2100	1860	1640	1430
		3	24	28	13	3120	2430	2150	1900	1650
1" Dia. copper	1C-2 3/4 X 4-32	1	12	16	4.0	968	755	668	590	513
		1	18	22	4.3	1020	796	704	622	541
		2	18	22	6.3	1517	1183	1047	926	804
		1	24	28	4.6	1099	857	758	670	582
		2	24	28	7.1	1700	1326	1173	1037	901
		3	24	28	8.3	1998	1558	1379	1219	1059
	1C-2 3/4 X 4-40	1	12	16	5.1	1220	952	842	744	647
		1	18	22	5.5	1329	1037	917	811	704
		2	18	22	7.3	1742	1359	1202	1063	923
		1	24	28	6.0	1437	1121	992	877	762
		2	24	28	8.0	1927	1503	1330	1176	1021
		3	24	28	9.7	2326	1814	1605	1419	1233
	1C-2 3/4 X 4-48	1	12	16	5.2	1258	981	868	768	667
		1	18	22	6.1	1464	1142	1010	893	776
		2	18	22	7.3	1763	1375	1216	1075	934
		1	24	28	6.7	1618	1262	1116	987	857
		2	24	28	8.6	2061	1608	1422	1257	1092
		3	24	28	10.2	2450	1911	1690	1494	1298

*EDR - Equivalent Direct Radiation area (for steam heat) per active (finned) lineal foot of tube.

Important rating information Performance ratings based on:

- Installation at height shown. (Lower heights are not recommended; for greater heights refer to EZselect selection software).
- Entering air temperature of 65°F. (For other temperatures, refer to EZselect selection software).

- Steam at nominal 1 (actual 0.9) psig and 215°F. (For other conditions, refer to EZselect selection software).
- Water average temperature (°F) shown and velocity of 3 fps or more. (For lower velocities, refer to EZselect selection software).

Revised February 2016. Zehnder periodically makes changes to the design and/or specifications of its products. As a result, the design and specifications of each product at the time of order may be different than as described herein. Please contact Zehnder's Sales Support staff at 844-934-6337 for specific information on current design and specifications. Designs, specifications and other information contained herein are not express warranties, which are only as expressly set forth by Zehnder in its terms and conditions of sale. The latest version of this document is available at www.zehnder-ritting.com.

Enclosure Submittal Data

English, IP Units

General data

Performance ratings: model S-SP5/PS5; perforated enclosure

In BTU/hr per active (finned) lineal foot of tube at entering air temperature of 65°F

Element	Rows of element (on 6-inch centers)	Enclosure height (in inches)	Recommended minimum installed height (in inches)	EDR* (ft ² /ft)	Steam heat	Hot water heat				
					215°F factor of 1.00	190°F factor of 0.78	180°F factor of 0.69	170°F factor of 0.61	160°F factor of 0.53	
Copper element										
1" Dia. copper	1C-3 ¹ / ₄ X 3 ¹ / ₄ -32	1	12	16	3.7	880	690	610	540	470
		1	18	22	3.9	940	730	650	570	500
		2	18	22	5.8	1380	1080	950	840	730
		1	24	28	4.2	1000	780	690	610	530
		2	24	28	6.5	1570	1220	1080	960	830
		3	24	28	7.5	1810	1410	1250	1100	960
	1C-3 ¹ / ₄ X 3 ¹ / ₄ -40	1	12	16	4.5	1080	840	750	660	570
		1	18	22	4.9	1180	920	810	720	630
		2	18	22	6.6	1580	1230	1090	960	840
		1	24	28	5.3	1280	1000	880	780	680
		2	24	28	7.3	1760	1370	1210	1070	930
		3	24	28	8.5	2040	1590	1410	1240	1080
	1C-3 ¹ / ₄ X 3 ¹ / ₄ -48	1	12	16	4.9	1170	910	810	710	620
		1	18	22	5.7	1360	1060	940	830	720
		2	18	22	6.5	1560	1220	1080	950	830
		1	24	28	6.3	1510	1180	1040	920	800
		2	24	28	7.6	1820	1420	1260	1110	960
		3	24	28	8.8	2100	1640	1450	1280	1110
1" Dia. copper	1C-4 ¹ / ₄ X 4 ¹ / ₄ -32	1	12	16	5.3	1280	1000	880	780	680
		1	18	22	5.7	1360	1060	940	830	720
		2	18	22	8.4	2010	1570	1390	1230	1070
		1	24	28	6	1450	1130	1000	890	770
		2	24	28	9.4	2260	1760	1560	1380	1200
		3	24	28	10.8	2590	2020	1790	1580	1370
	1C-4 ¹ / ₄ X 4 ¹ / ₄ -40	1	12	16	6.3	1500	1170	1040	920	800
		1	18	22	6.8	1630	1270	1130	990	860
		2	18	22	9.1	2200	1700	1500	1330	1160
		1	24	28	7.3	1750	1370	1210	1070	930
		2	24	28	10.2	2440	1900	1680	1490	1290
		3	24	28	11.7	2810	2190	1940	1710	1490
	1C-4 ¹ / ₄ X 4 ¹ / ₄ -48	1	12	16	6.6	1430	1230	1090	960	840
		1	18	22	7.5	1810	1410	1250	1100	960
		2	18	22	8.7	2090	1630	1440	1280	1110
		1	24	28	8.5	2030	1580	1400	1240	1080
		2	24	28	11	2640	2060	1820	1610	1400
		3	24	28	12.6	3020	2360	2090	1840	1600

*EDR - Equivalent Direct Radiation area (for steam heat) per active (finned) lineal foot of tube.

Important rating information Performance ratings based on:

- Installation at height shown. (Lower heights are not recommended; for greater heights refer to EZselect selection software).
- Entering air temperature of 65°F. (For other temperatures, refer to EZselect selection software).

- Steam at nominal 1 (actual 0.9) psig and 215°F. (For other conditions, refer to EZselect selection software).
- Water average temperature (°F) shown and velocity of 3 fps or more. (For lower velocities, refer to EZselect selection software).

Revised February 2016. Zehnder periodically makes changes to the design and/or specifications of its products. As a result, the design and specifications of each product at the time of order may be different than as described herein. Please contact Zehnder's Sales Support staff at 844-934-6337 for specific information on current design and specifications. Designs, specifications and other information contained herein are not express warranties, which are only as expressly set forth by Zehnder in its terms and conditions of sale. The latest version of this document is available at www.zehnder-ritting.com.

Enclosure Submittal Data

English, IP Units

General data

Performance ratings: model S-SP5/PS5; perforated enclosure

In BTU/hr per active (finned) lineal foot of tube at entering air temperature of 65°F

Element	Rows of element (on 6-inch centers)	Enclosure height (in inches)	Recommended minimum installed height (in inches)	EDR* (ft ² /ft)	Steam heat	Hot water heat				
					215°F factor of 1.00	190°F factor of 0.78	180°F factor of 0.69	170°F factor of 0.61	160°F factor of 0.53	
Copper element										
1 1/4" Dia. copper	1 1/4C-2 3/4 X 4-32	1	12	16	4.1	992	774	685	605	526
		1	18	22	4.4	1048	818	723	639	556
		2	18	22	6.6	1594	1243	1100	972	845
		1	24	28	4.6	1104	861	762	674	585
		2	24	28	7.4	1786	1393	1232	1089	946
		3	24	28	8.8	2112	1647	1457	1288	1119
	1 1/4C-2 3/4 X 4-40	1	12	16	5.1	1220	952	842	744	647
		1	18	22	5.5	1319	1028	910	804	699
		2	18	22	7.5	1793	1398	1237	1094	950
		1	24	28	5.9	1417	1105	978	864	751
		2	24	28	8.3	1992	1554	1374	1215	1056
		3	24	28	10.0	2401	1873	1657	1465	1273
	1 1/4C-2 3/4 X 4-48	1	12	16	5.2	1248	973	861	761	661
		1	18	22	6.0	1440	1123	994	878	763
		2	18	22	7.4	1775	1385	1225	1083	941
		1	24	28	6.6	1594	1243	1100	972	845
		2	24	28	9.2	2208	1723	1524	1347	1170
		3	24	28	11.3	2708	2112	1869	1652	1435
1 1/4" Dia. copper	1 1/4C-3 1/4 X 3 1/4-32	1	12	16	3.8	916	714	632	559	485
		1	18	22	4.0	968	755	668	590	513
		2	18	22	6.1	1454	1134	1003	887	771
		1	24	28	4.2	1020	795	703	622	540
		2	24	28	6.8	1629	1271	1124	994	864
		3	24	28	8.0	1908	1488	1317	1164	1011
	1 1/4C-3 1/4 X 3 1/4-40	1	12	16	4.5	1071	836	739	654	568
		1	18	22	4.8	1158	903	799	706	614
		2	18	22	6.8	1620	1264	1118	988	859
		1	24	28	5.2	1244	970	858	759	659
		2	24	28	7.5	1800	1404	1242	1098	954
		3	24	28	8.7	2098	1636	1447	1280	1112
	1 1/4C-3 1/4 X 3 1/4-48	1	12	16	4.9	1170	913	807	714	620
		1	18	22	5.6	1350	1053	932	824	716
		2	18	22	6.5	1569	1224	1082	957	831
		1	24	28	6.2	1494	1165	1031	911	792
		2	24	28	8.1	1952	1522	1347	1191	1034
		3	24	28	9.7	2321	1811	1602	1416	1230

*EDR - Equivalent Direct Radiation area (for steam heat) per active (finned) lineal foot of tube.

Important rating information Performance ratings based on:

- Installation at height shown. (Lower heights are not recommended; for greater heights refer to EZselect selection software).
- Entering air temperature of 65°F. (For other temperatures, refer to EZselect selection software).

- Steam at nominal 1 (actual 0.9) psig and 215°F. (For other conditions, refer to EZselect selection software).
- Water average temperature (°F) shown and velocity of 3 fps or more. (For lower velocities, refer to EZselect selection software).

Revised February 2016. Zehnder periodically makes changes to the design and/or specifications of its products. As a result, the design and specifications of each product at the time of order may be different than as described herein. Please contact Zehnder's Sales Support staff at 844-934-6337 for specific information on current design and specifications. Designs, specifications and other information contained herein are not express warranties, which are only as expressly set forth by Zehnder in its terms and conditions of sale. The latest version of this document is available at www.zehnder-ritting.com.

Enclosure Submittal Data

English, IP Units

General data

Performance ratings: model S-SP5/PS5; perforated enclosure

In BTU/hr per active (finned) lineal foot of tube at entering air temperature of 65°F

Element	Rows of element (on 6-inch centers)	Enclosure height (in inches)	Recommended minimum installed height (in inches)	EDR* (ft ² /ft)	Steam heat	Hot water heat				
					215°F factor of 1.00	190°F factor of 0.78	180°F factor of 0.69	170°F factor of 0.61	160°F factor of 0.53	
Copper element										
1 1/4" Dia. copper	1 1/4C-4 1/4 X 4 1/4-32	1	12	16	5.3	1260	980	870	770	670
		1	18	22	5.6	1340	1050	930	820	710
		2	18	22	8.3	1990	1550	1370	1210	1060
		1	24	28	5.9	1420	1110	980	870	750
		2	24	28	9.3	2220	1730	1530	1350	1180
		3	24	28	10.6	2550	1990	1760	1560	1350
	1 1/4C-4 1/4 X 4 1/4-40	1	12	16	6.2	1480	1150	1020	900	780
		1	18	22	6.7	1610	1260	1110	980	850
		2	18	22	9	2160	1690	1490	1320	1150
		1	24	28	7.2	1730	1350	1190	1060	920
		2	24	28	10	2400	1870	1660	1460	1270
		3	24	28	11.5	2770	2160	1910	1690	1470
	1 1/4C-4 1/4 X 4 1/4-48	1	12	16	6.5	1550	1210	1070	950	820
		1	18	22	7.5	1790	1400	1240	1090	950
		2	18	22	8.6	2070	1620	1430	1260	1100
		1	24	28	8.3	2000	1560	1380	1220	1060
		2	24	28	10.7	2570	2000	1770	1570	1360
		3	24	28	12.4	2980	2320	2050	1820	1580

*EDR - Equivalent Direct Radiation area (for steam heat) per active (finned) lineal foot of tube.

Important rating information Performance ratings based on:

- Installation at height shown. (Lower heights are not recommended; for greater heights refer to EZselect selection software).
- Entering air temperature of 65°F. (For other temperatures, refer to EZselect selection software).

- Steam at nominal 1 (actual 0.9) psig and 215°F. (For other conditions, refer to EZselect selection software).
- Water average temperature (°F) shown and velocity of 3 fps or more. (For lower velocities, refer to EZselect selection software).

Enclosure Submittal Data

English, IP Units

General data

Performance ratings: model S-SL; louvered enclosure

In BTU/hr per active (finned) lineal foot of tube at entering air temperature of 65°F

Element	Rows of element (on 6-inch centers)	Enclosure height (in inches)	Recommended minimum installed height (in inches)	EDR* (ft ² /ft)	Steam heat	Hot water heat				
					215°F factor of 1.00	190°F factor of 0.78	180°F factor of 0.69	170°F factor of 0.61	160°F factor of 0.53	
Steel element										
1" Dia. steel	1S-3¹/₄ X 3¹/₄-32	1	12	16	3.63	871	680	601	531	462
		1	18	22	3.77	904	705	624	552	479
		2	18	22	5.67	1360	1060	938	829	721
		1	24	28	3.96	950	741	656	580	504
		2	24	28	6.00	1439	1122	993	878	763
		3	24	28	6.93	1663	1297	1148	1015	881
	1S-3¹/₄ X 3¹/₄-40	1	12	16	4.02	964	752	665	588	511
		1	18	22	4.35	1043	813	720	636	553
		2	18	22	6.22	1492	1163	1029	910	791
		1	24	28	4.62	1109	865	765	676	588
		2	24	28	6.60	1584	1236	1093	966	840
		3	24	28	7.54	1808	1411	1248	1103	958
	1S-3¹/₄ X 3¹/₄-48	1	12	16	4.62	1109	865	765	676	588
		1	18	22	5.14	1234	963	852	753	654
		2	18	22	6.79	1630	1272	1125	994	864
		1	24	28	5.42	1300	1014	897	793	689
		2	24	28	7.21	1729	1349	1193	1055	916
		3	24	28	8.31	1993	1555	1375	1216	1056
1" Dia. steel	1S-4¹/₄ X 4¹/₄-32	1	12	16	5.50	1320	1030	911	805	700
		1	18	22	5.71	1370	1069	945	836	726
		2	18	22	8.58	2060	1607	1421	1257	1092
		1	24	28	6.00	1440	1123	994	878	763
		2	24	28	9.08	2180	1700	1504	1330	1155
		3	24	28	10.50	2520	1966	1739	1537	1336
	1S-4¹/₄ X 4¹/₄-40	1	12	16	6.08	1460	1139	1007	891	774
		1	18	22	6.58	1580	1232	1090	964	837
		2	18	22	9.42	2260	1763	1559	1379	1198
		1	24	28	7.00	1680	1310	1159	1025	890
		2	24	28	10.00	2400	1872	1656	1464	1272
		3	24	28	11.42	2740	2137	1891	1671	1452
	1S-4¹/₄ X 4¹/₄-48	1	12	16	7.00	1680	1310	1159	1025	890
		1	18	22	7.79	1870	1459	1290	1141	991
		2	18	22	10.29	2470	1927	1704	1507	1309
		1	24	28	8.21	1970	1537	1359	1202	1044
		2	24	28	10.92	2620	2044	1808	1598	1389
		3	24	28	12.58	3020	2356	2084	1842	1601

*EDR - Equivalent Direct Radiation area (for steam heat) per active (finned) lineal foot of tube.

Important rating information Performance ratings based on:

- Installation at height shown. (Lower heights are not recommended; for greater heights refer to EZselect selection software).
- Entering air temperature of 65°F. (For other temperatures, refer to EZselect selection software).

- Steam at nominal 1 (actual 0.9) psig and 215°F. (For other conditions, refer to EZselect selection software).
- Water average temperature (°F) shown and velocity of 3 fps or more. (For lower velocities, refer to EZselect selection software).

Revised February 2016. Zehnder periodically makes changes to the design and/or specifications of its products. As a result, the design and specifications of each product at the time of order may be different than as described herein. Please contact Zehnder's Sales Support staff at 844-934-6337 for specific information on current design and specifications. Designs, specifications and other information contained herein are not express warranties, which are only as expressly set forth by Zehnder in its terms and conditions of sale. The latest version of this document is available at www.zehnder-ritting.com.

Enclosure Submittal Data

English, IP Units

General data

Performance ratings: model S-SL; louvered enclosure

In BTU/hr per active (finned) lineal foot of tube at entering air temperature of 65°F

Element	Rows of element (on 6-inch centers)	Enclosure height (in inches)	Recommended minimum installed height (in inches)	EDR* (ft ² /ft)	Steam heat	Hot water heat				
					215°F factor of 1.00	190°F factor of 0.78	180°F factor of 0.69	170°F factor of 0.61	160°F factor of 0.53	
Steel element										
1 1/4" Dia. steel	1 1/4S-3 1/4 X 3 1/4-32	1	12	16	3.71	890	694	614	543	472
		1	18	22	3.79	910	710	628	555	482
		2	18	22	5.79	1390	1084	959	848	737
		1	24	28	4.08	980	764	676	598	519
		2	24	28	6.21	1490	1162	1028	909	790
		3	24	28	7.08	1700	1326	1173	1037	901
	1 1/4S-3 1/4 X 3 1/4-40	1	12	16	4.21	1010	788	697	616	535
		1	18	22	4.50	1080	842	745	659	572
		2	18	22	6.29	1510	1178	1042	921	800
		1	24	28	4.79	1150	897	794	702	610
		2	24	28	6.79	1630	1271	1125	994	864
		3	24	28	7.79	1870	1459	1290	1141	991
	1 1/4S-3 1/4 X 3 1/4-48	1	12	16	4.71	1130	881	780	689	599
		1	18	22	5.21	1250	975	863	763	663
		2	18	22	7.00	1680	1310	1159	1025	890
		1	24	28	5.50	1320	1030	911	805	700
		2	24	28	7.42	1780	1388	1228	1086	943
		3	24	28	8.58	2060	1607	1421	1257	1092
1 1/4" Dia. steel	1 1/4S-4 1/4 X 4 1/4-32	1	12	16	5.42	1300	1014	897	793	689
		1	18	22	5.58	1340	1045	925	817	710
		2	18	22	8.42	2020	1576	1394	1232	1071
		1	24	28	5.92	1420	1108	980	866	753
		2	24	28	8.92	2140	1669	1477	1305	1134
		3	24	28	10.29	2470	1927	1704	1507	1309
	1 1/4S-4 1/4 X 4 1/4-40	1	12	16	6.08	1460	1139	1007	891	774
		1	18	22	6.50	1560	1217	1076	952	827
		2	18	22	9.21	2210	1724	1525	1348	1171
		1	24	28	6.79	1630	1271	1125	994	864
		2	24	28	9.79	2350	1833	1622	1434	1246
		3	24	28	11.21	2690	2098	1856	1641	1426
	1 1/4S-4 1/4 X 4 1/4-48	1	12	16	6.79	1630	1271	1125	994	864
		1	18	22	7.58	1820	1420	1256	1110	965
		2	18	22	10.08	2420	1888	1670	1476	1283
		1	24	28	8.00	1920	1498	1325	1171	1018
		2	24	28	10.71	2570	2005	1773	1568	1362
		3	24	28	12.42	2980	2324	2056	1818	1579

*EDR - Equivalent Direct Radiation area (for steam heat) per active (finned) lineal foot of tube.

Important rating information Performance ratings based on:

- Installation at height shown. (Lower heights are not recommended; for greater heights refer to EZselect selection software).
- Entering air temperature of 65°F. (For other temperatures, refer to EZselect selection software).

- Steam at nominal 1 (actual 0.9) psig and 215°F. (For other conditions, refer to EZselect selection software).
- Water average temperature (°F) shown and velocity of 3 fps or more. (For lower velocities, refer to EZselect selection software).

Revised February 2016. Zehnder periodically makes changes to the design and/or specifications of its products. As a result, the design and specifications of each product at the time of order may be different than as described herein. Please contact Zehnder's Sales Support staff at 844-934-6337 for specific information on current design and specifications. Designs, specifications and other information contained herein are not express warranties, which are only as expressly set forth by Zehnder in its terms and conditions of sale. The latest version of this document is available at www.zehnder-ritting.com.

Enclosure Submittal Data

English, IP Units

General data

Performance ratings: model S-SL; louvered enclosure

In BTU/hr per active (finned) lineal foot of tube at entering air temperature of 65°F

Element	Rows of element (on 6-inch centers)	Enclosure height (in inches)	Recommended minimum installed height (in inches)	EDR* (ft ² /ft)	Steam heat	Hot water heat				
					215°F factor of 1.00	190°F factor of 0.78	180°F factor of 0.69	170°F factor of 0.61	160°F factor of 0.53	
Steel element										
2" Dia. steel	2S-4 ¹ / ₄ X 4 ¹ / ₄ -32	1	12	16	5.34	1281	999	884	781	679
		1	18	22	5.50	1320	1030	911	805	700
		2	18	22	8.29	1990	1552	1373	1214	1055
		1	24	28	5.83	1399	1091	965	853	741
		2	24	28	8.78	2108	1644	1454	1286	1117
		3	24	28	10.14	2433	1898	1679	1484	1289
	2S-4 ¹ / ₄ X 4 ¹ / ₄ -40	1	12	16	5.99	1438	1122	992	877	762
		1	18	22	6.40	1537	1199	1060	937	814
		2	18	22	9.07	2177	1698	1502	1328	1154
		1	24	28	6.69	1606	1252	1108	979	851
		2	24	28	9.64	2315	1806	1597	1412	1227
		3	24	28	11.04	2650	2067	1828	1616	1404
	2S-4 ¹ / ₄ X 4 ¹ / ₄ -48	1	12	16	6.69	1606	1252	1108	979	851
		1	18	22	7.47	1793	1398	1237	1094	950
		2	18	22	9.93	2384	1859	1645	1454	1263
		1	24	28	7.88	1891	1475	1305	1154	1002
		2	24	28	10.55	2531	1975	1747	1544	1342
		3	24	28	12.23	2935	2290	2025	1791	1556

*EDR - Equivalent Direct Radiation area (for steam heat) per active (finned) lineal foot of tube.

Important rating information Performance ratings based on:

- Installation at height shown. (Lower heights are not recommended; for greater heights refer to EZselect selection software).
- Entering air temperature of 65°F. (For other temperatures, refer to EZselect selection software).

- Steam at nominal 1 (actual 0.9) psig and 215°F. (For other conditions, refer to EZselect selection software).
- Water average temperature (°F) shown and velocity of 3 fps or more. (For lower velocities, refer to EZselect selection software).

Enclosure Submittal Data

English, IP Units

General data

Performance ratings: model S-SL; louvered enclosure

In BTU/hr per active (finned) lineal foot of tube at entering air temperature of 65°F

Element	Rows of element (on 6-inch centers)	Enclosure height (in inches)	Recommended minimum installed height (in inches)	EDR* (ft ² /ft)	Steam heat	Hot water heat				
					215°F factor of 1.00	190°F factor of 0.78	180°F factor of 0.69	170°F factor of 0.61	160°F factor of 0.53	
Copper element										
3/4" Dia. copper	3/4C-2³/₄ X 4-32	1	12	16	4.24	1016	793	701	620	539
		1	18	22	4.48	1076	839	742	656	570
		2	18	22	6.66	1597	1246	1102	974	847
		1	24	28	4.81	1155	901	797	705	612
		2	24	28	7.54	1808	1411	1248	1103	958
		3	24	28	8.64	2072	1616	1430	1264	1098
	3/4C-2³/₄ X 4-40	1	12	16	5.01	1201	937	829	733	637
		1	18	22	5.47	1313	1024	906	801	696
		2	18	22	7.12	1709	1333	1179	1043	906
		1	24	28	5.80	1393	1086	961	849	738
		2	24	28	7.92	1901	1483	1312	1159	1007
		3	24	28	9.05	2171	1694	1498	1325	1151
	3/4C-2³/₄ X 4-48	1	12	16	5.42	1300	1014	897	793	689
		1	18	22	6.13	1472	1148	1016	898	780
		2	18	22	7.32	1756	1369	1211	1071	930
		1	24	28	6.79	1630	1272	1125	994	864
		2	24	28	8.20	1967	1534	1357	1200	1042
		3	24	28	9.38	2251	1755	1553	1373	1193
3/4" Dia. copper	3/4C-3¹/₄ X 3¹/₄-32	1	12	16	4.92	1180	920	814	720	625
		1	18	22	5.42	1300	1014	897	793	689
		2	18	22	7.50	1800	1404	1242	1098	954
		1	24	28	5.79	1390	1084	959	848	737
		2	24	28	8.58	2060	1607	1421	1257	1092
		3	24	28	9.79	2350	1833	1622	1434	1246
	3/4C-3¹/₄ X 3¹/₄-40	1	12	16	5.50	1320	1030	911	805	700
		1	18	22	6.08	1460	1139	1007	891	774
		2	18	22	8.79	2110	1646	1456	1287	1118
		1	24	28	6.58	1580	1232	1090	964	837
		2	24	28	9.21	2210	1724	1525	1348	1171
		3	24	28	10.21	2450	1911	1691	1495	1299
	3/4C-3¹/₄ X 3¹/₄-48	1	12	16	6.00	1440	1123	994	878	763
		1	18	22	6.92	1660	1295	1145	1013	880
		2	18	22	9.00	2160	1685	1490	1318	1145
		1	24	28	7.50	1800	1404	1242	1098	954
		2	24	28	9.50	2280	1778	1573	1391	1208
		3	24	28	10.50	2520	1966	1739	1537	1336

*EDR - Equivalent Direct Radiation area (for steam heat) per active (finned) lineal foot of tube.

Important rating information Performance ratings based on:

- Installation at height shown. (Lower heights are not recommended; for greater heights refer to EZselect selection software).
- Entering air temperature of 65°F. (For other temperatures, refer to EZselect selection software).

- Steam at nominal 1 (actual 0.9) psig and 215°F. (For other conditions, refer to EZselect selection software).
- Water average temperature (°F) shown and velocity of 3 fps or more. (For lower velocities, refer to EZselect selection software).

Revised February 2016. Zehnder periodically makes changes to the design and/or specifications of its products. As a result, the design and specifications of each product at the time of order may be different than as described herein. Please contact Zehnder's Sales Support staff at 844-934-6337 for specific information on current design and specifications. Designs, specifications and other information contained herein are not express warranties, which are only as expressly set forth by Zehnder in its terms and conditions of sale. The latest version of this document is available at www.zehnder-ritting.com.

Enclosure Submittal Data

English, IP Units

General data

Performance ratings: model S-SL; louvered enclosure

In BTU/hr per active (finned) lineal foot of tube at entering air temperature of 65°F

Element	Rows of element (on 6-inch centers)	Enclosure height (in inches)	Recommended minimum installed height (in inches)	EDR* (ft ² /ft)	Steam heat	Hot water heat				
					215°F factor of 1.00	190°F factor of 0.78	180°F factor of 0.69	170°F factor of 0.61	160°F factor of 0.53	
Copper element										
3/4" Dia. copper	3/4C-4 1/4 X 4 1/4-32	1	12	16	6.42	1540	1201	1063	939	816
		1	18	22	6.79	1630	1271	1125	994	864
		2	18	22	10.08	2420	1888	1670	1476	1283
		1	24	28	7.29	1750	1365	1208	1068	928
		2	24	28	11.42	2740	2137	1891	1671	1452
		3	24	28	13.08	3140	2449	2167	1915	1664
	3/4C-4 1/4 X 4 1/4-40	1	12	16	7.58	1820	1420	1256	1110	965
		1	18	22	8.29	1990	1552	1373	1214	1055
		2	18	22	10.79	2590	2020	1787	1580	1373
		1	24	28	8.79	2110	1646	1456	1287	1118
		2	24	28	12.00	2880	2246	1987	1757	1526
		3	24	28	13.71	3290	2566	2270	2007	1744
	3/4C-4 1/4 X 4 1/4-48	1	12	16	8.21	1970	1537	1359	1202	1044
		1	18	22	9.29	2230	1739	1539	1360	1182
		2	18	22	11.08	2660	2075	1835	1623	1410
		1	24	28	10.29	2470	1927	1704	1507	1309
		2	24	28	12.42	2980	2324	2056	1818	1579
		3	24	28	14.21	3410	2660	2353	2080	1807
1" Dia. copper	1C-2 3/4 X 4-32	1	12	16	4.15	997	777	688	608	528
		1	18	22	4.43	1063	829	733	648	563
		2	18	22	6.60	1584	1236	1093	966	840
		1	24	28	4.68	1122	875	774	684	595
		2	24	28	7.40	1775	1385	1225	1083	941
		3	24	28	8.44	2026	1580	1398	1236	1074
	1C-2 3/4 X 4-40	1	12	16	4.90	1175	916	811	717	623
		1	18	22	5.34	1280	999	883	781	679
		2	18	22	6.99	1676	1308	1157	1023	888
		1	24	28	5.75	1379	1076	952	841	731
		2	24	28	7.78	1868	1457	1289	1139	990
		3	24	28	8.86	2125	1658	1466	1296	1126
	1C-2 3/4 X 4-48	1	12	16	5.28	1267	988	874	773	672
		1	18	22	6.00	1439	1122	993	878	763
		2	18	22	7.21	1729	1349	1193	1055	916
		1	24	28	6.66	1597	1246	1102	974	847
		2	24	28	7.98	1914	1493	1321	1168	1014
		3	24	28	9.19	2204	1719	1521	1345	1168

*EDR - Equivalent Direct Radiation area (for steam heat) per active (finned) lineal foot of tube.

Important rating information Performance ratings based on:

- Installation at height shown. (Lower heights are not recommended; for greater heights refer to EZselect selection software).
- Entering air temperature of 65°F. (For other temperatures, refer to EZselect selection software).

- Steam at nominal 1 (actual 0.9) psig and 215°F. (For other conditions, refer to EZselect selection software).
- Water average temperature (°F) shown and velocity of 3 fps or more. (For lower velocities, refer to EZselect selection software).

Revised February 2016. Zehnder periodically makes changes to the design and/or specifications of its products. As a result, the design and specifications of each product at the time of order may be different than as described herein. Please contact Zehnder's Sales Support staff at 844-934-6337 for specific information on current design and specifications. Designs, specifications and other information contained herein are not express warranties, which are only as expressly set forth by Zehnder in its terms and conditions of sale. The latest version of this document is available at www.zehnder-ritting.com.

Enclosure Submittal Data

English, IP Units

General data

Performance ratings: model S-SL; louvered enclosure

In BTU/hr per active (finned) lineal foot of tube at entering air temperature of 65°F

Element	Rows of element (on 6-inch centers)	Enclosure height (in inches)	Recommended minimum installed height (in inches)	EDR* (ft ² /ft)	Steam heat	Hot water heat				
					215°F factor of 1.00	190°F factor of 0.78	180°F factor of 0.69	170°F factor of 0.61	160°F factor of 0.53	
Copper element										
1" Dia. copper	1C-3 ¹ / ₄ X 3 ¹ / ₄ -32	1	12	16	4.79	1150	897	794	702	610
		1	18	22	5.29	1270	991	876	775	673
		2	18	22	7.42	1780	1388	1228	1086	943
		1	24	28	5.71	1370	1069	945	836	726
		2	24	28	8.42	2020	1576	1394	1232	1071
		3	24	28	9.58	2300	1794	1587	1403	1219
	1C-3 ¹ / ₄ X 3 ¹ / ₄ -40	1	12	16	5.42	1300	1014	897	793	689
		1	18	22	6.00	1440	1123	994	878	763
		2	18	22	8.58	2060	1607	1421	1257	1092
		1	24	28	6.50	1560	1217	1076	952	827
		2	24	28	9.00	2160	1685	1490	1318	1145
		3	24	28	10.08	2420	1888	1670	1476	1283
	1C-3 ¹ / ₄ X 3 ¹ / ₄ -48	1	12	16	5.92	1420	1108	980	866	753
		1	18	22	6.71	1610	1256	1111	982	853
		2	18	22	8.79	2110	1646	1456	1287	1118
		1	24	28	7.29	1750	1365	1208	1068	928
		2	24	28	9.29	2230	1739	1539	1360	1182
		3	24	28	10.29	2470	1927	1704	1507	1309
1" Dia. copper	1C-4 ¹ / ₄ X 4 ¹ / ₄ -32	1	12	16	6.29	1510	1178	1042	921	800
		1	18	22	6.71	1610	1256	1111	982	853
		2	18	22	10.00	2400	1872	1656	1464	1272
		1	24	28	7.08	1700	1326	1173	1037	901
		2	24	28	11.21	2690	2098	1856	1641	1426
		3	24	28	12.79	3070	2395	2118	1873	1627
	1C-4 ¹ / ₄ X 4 ¹ / ₄ -40	1	12	16	7.42	1780	1388	1228	1086	943
		1	18	22	8.08	1940	1513	1339	1183	1028
		2	18	22	10.58	2540	1981	1753	1549	1346
		1	24	28	8.71	2090	1630	1442	1275	1108
		2	24	28	11.79	2830	2207	1953	1726	1500
		3	24	28	13.42	3220	2512	2222	1964	1707
	1C-4 ¹ / ₄ X 4 ¹ / ₄ -48	1	12	16	8.00	1920	1498	1325	1171	1018
		1	18	22	9.08	2180	1700	1504	1330	1155
		2	18	22	10.92	2620	2044	1808	1598	1389
		1	24	28	10.08	2420	1888	1670	1476	1283
		2	24	28	12.08	2900	2262	2001	1769	1537
		3	24	28	13.92	3340	2605	2305	2037	1770

*EDR - Equivalent Direct Radiation area (for steam heat) per active (finned) lineal foot of tube.

Important rating information Performance ratings based on:

- Installation at height shown. (Lower heights are not recommended; for greater heights refer to EZselect selection software).
- Entering air temperature of 65°F. (For other temperatures, refer to EZselect selection software).

- Steam at nominal 1 (actual 0.9) psig and 215°F. (For other conditions, refer to EZselect selection software).
- Water average temperature (°F) shown and velocity of 3 fps or more. (For lower velocities, refer to EZselect selection software).

Revised February 2016. Zehnder periodically makes changes to the design and/or specifications of its products. As a result, the design and specifications of each product at the time of order may be different than as described herein. Please contact Zehnder's Sales Support staff at 844-934-6337 for specific information on current design and specifications. Designs, specifications and other information contained herein are not express warranties, which are only as expressly set forth by Zehnder in its terms and conditions of sale. The latest version of this document is available at www.zehnder-ritting.com.

Enclosure Submittal Data

English, IP Units

General data

Performance ratings: model S-SL; louvered enclosure

In BTU/hr per active (finned) lineal foot of tube at entering air temperature of 65°F

Element	Rows of element (on 6-inch centers)	Enclosure height (in inches)	Recommended minimum installed height (in inches)	EDR* (ft ² /ft)	Steam heat	Hot water heat				
					215°F factor of 1.00	190°F factor of 0.78	180°F factor of 0.69	170°F factor of 0.61	160°F factor of 0.53	
Copper element										
1 1/4" Dia. copper	1 1/4C-2 3/4 X 4-32	1	12	16	4.10	983	767	679	600	521
		1	18	22	4.35	1043	813	720	636	553
		2	18	22	6.46	1551	1210	1070	946	822
		1	24	28	4.62	1109	865	765	676	588
		2	24	28	7.26	1742	1359	1202	1063	923
		3	24	28	8.31	1993	1555	1375	1216	1056
	1 1/4C-2 3/4 X 4-40	1	12	16	4.81	1155	901	797	705	612
		1	18	22	5.28	1267	988	874	773	672
		2	18	22	6.88	1650	1287	1139	1007	875
		1	24	28	5.67	1360	1060	938	829	721
		2	24	28	7.65	1835	1431	1266	1119	972
		3	24	28	8.72	2092	1632	1444	1276	1109
	1 1/4C-2 3/4 X 4-48	1	12	16	5.23	1254	978	865	765	665
		1	18	22	5.94	1426	1112	984	870	756
		2	18	22	7.07	1696	1323	1170	1035	899
		1	24	28	6.55	1571	1225	1084	958	833
		2	24	28	7.87	1888	1472	1302	1151	1000
		3	24	28	9.05	2171	1694	1498	1325	1151
1 1/4" Dia. copper	1 1/4C-3 1/4 X 3 1/4-32	1	12	16	4.50	1080	842	745	659	572
		1	18	22	5.08	1220	952	842	744	647
		2	18	22	7.21	1730	1349	1194	1055	917
		1	24	28	5.50	1320	1030	911	805	700
		2	24	28	8.21	1970	1537	1359	1202	1044
		3	24	28	9.42	2260	1763	1559	1379	1198
	1 1/4C-3 1/4 X 3 1/4-40	1	12	16	5.29	1270	991	876	775	673
		1	18	22	5.79	1390	1084	959	848	737
		2	18	22	8.42	2020	1576	1394	1232	1071
		1	24	28	6.21	1490	1162	1028	909	790
		2	24	28	8.79	2110	1646	1456	1287	1118
		3	24	28	9.92	2380	1856	1642	1452	1261
	1 1/4C-3 1/4 X 3 1/4-48	1	12	16	5.71	1370	1069	945	836	726
		1	18	22	6.58	1580	1232	1090	964	837
		2	18	22	8.71	2090	1630	1442	1275	1108
		1	24	28	7.21	1730	1349	1194	1055	917
		2	24	28	9.08	2180	1700	1504	1330	1155
		3	24	28	10.21	2450	1911	1691	1495	1299

*EDR - Equivalent Direct Radiation area (for steam heat) per active (finned) lineal foot of tube.

Important rating information Performance ratings based on:

- Installation at height shown. (Lower heights are not recommended; for greater heights refer to EZselect selection software).
- Entering air temperature of 65°F. (For other temperatures, refer to EZselect selection software).

- Steam at nominal 1 (actual 0.9) psig and 215°F. (For other conditions, refer to EZselect selection software).
- Water average temperature (°F) shown and velocity of 3 fps or more. (For lower velocities, refer to EZselect selection software).

Revised February 2016. Zehnder periodically makes changes to the design and/or specifications of its products. As a result, the design and specifications of each product at the time of order may be different than as described herein. Please contact Zehnder's Sales Support staff at 844-934-6337 for specific information on current design and specifications. Designs, specifications and other information contained herein are not express warranties, which are only as expressly set forth by Zehnder in its terms and conditions of sale. The latest version of this document is available at www.zehnder-ritting.com.

Enclosure Submittal Data

English, IP Units

General data

Performance ratings: model S-SL; louvered enclosure

In BTU/hr per active (finned) lineal foot of tube at entering air temperature of 65°F

Element	Rows of element (on 6-inch centers)	Enclosure height (in inches)	Recommended minimum installed height (in inches)	EDR* (ft ² /ft)	Steam heat	Hot water heat				
					215°F factor of 1.00	190°F factor of 0.78	180°F factor of 0.69	170°F factor of 0.61	160°F factor of 0.53	
Copper element										
1 1/4" Dia. copper	1 1/4C-4 1/4 X 4 1/4-32	1	12	16	6.21	1490	1162	1028	909	790
		1	18	22	6.58	1580	1232	1090	964	837
		2	18	22	9.79	2350	1833	1622	1434	1246
		1	24	28	7.00	1680	1310	1159	1025	890
		2	24	28	11.00	2640	2059	1822	1610	1399
		3	24	28	12.58	3020	2356	2084	1842	1601
	1 1/4C-4 1/4 X 4 1/4-40	1	12	16	7.29	1750	1365	1208	1068	928
		1	18	22	8.00	1920	1498	1325	1171	1018
		2	18	22	10.42	2500	1950	1725	1525	1325
		1	24	28	8.58	2060	1607	1421	1257	1092
		2	24	28	11.58	2780	2168	1918	1696	1473
		3	24	28	13.21	3170	2473	2187	1934	1680
	1 1/4C-4 1/4 X 4 1/4-48	1	12	16	7.92	1900	1482	1311	1159	1007
		1	18	22	9.00	2160	1685	1490	1318	1145
		2	18	22	10.71	2570	2005	1773	1568	1362
		1	24	28	9.92	2380	1856	1642	1452	1261
		2	24	28	11.92	2860	2231	1973	1745	1516
		3	24	28	13.71	3290	2566	2270	2007	1744

*EDR - Equivalent Direct Radiation area (for steam heat) per active (finned) lineal foot of tube.

Important rating information Performance ratings based on:

- Installation at height shown. (Lower heights are not recommended; for greater heights refer to EZselect selection software).
- Entering air temperature of 65°F. (For other temperatures, refer to EZselect selection software).

- Steam at nominal 1 (actual 0.9) psig and 215°F. (For other conditions, refer to EZselect selection software).
- Water average temperature (°F) shown and velocity of 3 fps or more. (For lower velocities, refer to EZselect selection software).

Enclosure Submittal Data

English, IP Units

General data

Performance ratings: model S-DSP5; perforated enclosure

In BTU/hr per active (finned) lineal foot of tube at entering air temperature of 65°F

Element	Rows of element (on 6-inch centers)	Enclosure height (in inches)	Recommended minimum installed height (in inches)	EDR* (ft ² /ft)	Steam heat	Hot water heat				
					215°F factor of 1.00	190°F factor of 0.78	180°F factor of 0.69	170°F factor of 0.61	160°F factor of 0.53	
Steel element										
1" Dia. steel	1S-3¼ X 3¼-32	1	12	16	3.63	871	680	600	530	460
		1	18	22	3.82	917	720	630	560	490
		1	24	28	4.39	1053	820	730	640	560
		2	24	28	6.65	1595	1240	1100	970	850
	1S-3¼ X 3¼-40	1	12	16	4.02	964	750	670	590	510
		1	18	22	4.18	1004	780	690	610	530
		1	24	28	4.90	1176	920	810	720	620
		2	24	28	7.31	1755	1370	1210	1070	930
	1S-3¼ X 3¼-48	1	12	16	4.62	1109	870	770	680	590
		1	18	22	4.60	1104	860	760	670	590
		1	24	28	5.39	1293	1010	890	790	690
		2	24	28	8.04	1930	1510	1330	1180	1020
1" Dia. steel	1S-4¼ X 4¼-32	1	12	16	5.50	1320	1030	910	810	700
		1	18	22	5.10	1223	950	840	750	650
		1	24	28	5.85	1404	1100	970	860	740
		2	24	28	8.86	2126	1660	1470	1300	1130
	1S-4¼ X 4¼-40	1	12	16	6.08	1460	1140	1010	890	770
		1	18	22	5.58	1338	1040	920	820	710
		1	24	28	6.53	1568	1220	1080	960	830
		2	24	28	9.75	2340	1830	1610	1430	1240
	1S-4¼ X 4¼-48	1	12	16	7.00	1680	1310	1160	1020	890
		1	18	22	6.13	1472	1150	1020	900	780
		1	24	28	7.18	1724	1340	1190	1050	910
		2	24	28	10.73	2574	2010	1780	1570	1360

*EDR - Equivalent Direct Radiation area (for steam heat) per active (finned) lineal foot of tube.

Important rating information Performance ratings based on:

- Installation at height shown. (Lower heights are not recommended; for greater heights refer to EZselect selection software).
- Entering air temperature of 65°F. (For other temperatures, refer to EZselect selection software).

- Steam at nominal 1 (actual 0.9) psig and 215°F. (For other conditions, refer to EZselect selection software).
- Water average temperature (°F) shown and velocity of 3 fps or more. (For lower velocities, refer to EZselect selection software).

Enclosure Submittal Data

English, IP Units

General data

Performance ratings: model S-DSP5; perforated enclosure

In BTU/hr per active (finned) lineal foot of tube at entering air temperature of 65°F

Element	Rows of element (on 6-inch centers)	Enclosure height (in inches)	Recommended minimum installed height (in inches)	EDR* (ft ² /ft)	Steam heat	Hot water heat				
					215°F factor of 1.00	190°F factor of 0.78	180°F factor of 0.69	170°F factor of 0.61	160°F factor of 0.53	
Steel element										
1 1/4" Dia. steel	1 1/4S-3 1/4 X 3 1/4-32	1	12	16	3.71	890	690	610	540	470
		1	18	22	3.75	899	700	620	550	480
		1	24	28	4.30	1032	800	710	630	550
		2	24	28	6.52	1564	1220	1080	950	830
	1 1/4S-3 1/4 X 3 1/4-40	1	12	16	4.21	1010	790	700	620	540
		1	18	22	4.10	984	770	680	600	520
		1	24	28	4.80	1153	900	800	700	610
		2	24	28	7.17	1720	1340	1190	1050	910
	1 1/4S-3 1/4 X 3 1/4-48	1	12	16	4.71	1130	880	780	690	600
		1	18	22	4.51	1082	840	750	660	570
		1	24	28	5.28	1268	990	870	770	670
		2	24	28	7.88	1892	1480	1310	1150	1000
1 1/4" Dia. steel	1 1/4S-4 1/4 X 4 1/4-32	1	12	16	5.42	1300	1010	900	790	690
		1	18	22	5.00	1199	940	830	730	640
		1	24	28	5.74	1377	1070	950	840	730
		2	24	28	8.69	2085	1630	1440	1270	1110
	1 1/4S-4 1/4 X 4 1/4-40	1	12	16	6.08	1460	1140	1010	890	770
		1	18	22	5.47	1312	1020	910	800	700
		1	24	28	6.40	1537	1200	1060	940	810
		2	24	28	9.56	2294	1790	1580	1400	1220
	1 1/4S-4 1/4 X 4 1/4-48	1	12	16	6.79	1630	1270	1120	990	860
		1	18	22	6.01	1443	1130	1000	880	760
		1	24	28	7.05	1691	1320	1170	1030	900
		2	24	28	10.51	2523	1970	1740	1540	1340

*EDR - Equivalent Direct Radiation area (for steam heat) per active (finned) lineal foot of tube.

Important rating information Performance ratings based on:

- Installation at height shown. (Lower heights are not recommended; for greater heights refer to EZselect selection software).
- Entering air temperature of 65°F. (For other temperatures, refer to EZselect selection software).

- Steam at nominal 1 (actual 0.9) psig and 215°F. (For other conditions, refer to EZselect selection software).
- Water average temperature (°F) shown and velocity of 3 fps or more. (For lower velocities, refer to EZselect selection software).

Enclosure Submittal Data

English, IP Units

General data

Performance ratings: model S-DSP5; perforated enclosure

In BTU/hr per active (finned) lineal foot of tube at entering air temperature of 65°F

Element	Rows of element (on 6-inch centers)	Enclosure height (in inches)	Recommended minimum installed height (in inches)	EDR* (ft ² /ft)	Steam heat	Hot water heat				
					215°F factor of 1.00	190°F factor of 0.78	180°F factor of 0.69	170°F factor of 0.61	160°F factor of 0.53	
Steel element										
2" Dia. steel	2S-4¼ X 4¼-32	1	12	16	5.34	1281	1000	880	780	680
		1	18	22	4.91	1179	920	810	720	620
		1	24	28	5.69	1366	1070	940	830	720
		2	24	28	8.28	1986	1550	1370	1210	1050
	2S-4¼ X 4¼-40	1	12	16	5.99	1438	1120	990	880	760
		1	18	22	5.40	1297	1010	890	790	690
		1	24	28	6.26	1503	1170	1040	920	800
		2	24	28	9.10	2184	1700	1510	1330	1160
	2S-4¼ X 4¼-48	1	12	16	6.69	1606	1250	1110	980	850
		1	18	22	5.94	1426	1110	980	870	760
		1	24	28	6.89	1653	1290	1140	1010	880
		2	24	28	10.01	2402	1870	1660	1470	1270

*EDR - Equivalent Direct Radiation area (for steam heat) per active (finned) lineal foot of tube.

Important rating information Performance ratings based on:

- Installation at height shown. (Lower heights are not recommended; for greater heights refer to EZselect selection software).
- Entering air temperature of 65°F. (For other temperatures, refer to EZselect selection software).

- Steam at nominal 1 (actual 0.9) psig and 215°F. (For other conditions, refer to EZselect selection software).
- Water average temperature (°F) shown and velocity of 3 fps or more. (For lower velocities, refer to EZselect selection software).

Enclosure Submittal Data

English, IP Units

General data

Performance ratings: model S-DSP5; perforated enclosure

In BTU/hr per active (finned) lineal foot of tube at entering air temperature of 65°F

Element	Rows of element (on 6-inch centers)	Enclosure height (in inches)	Recommended minimum installed height (in inches)	EDR* (ft ² / ft)	Steam heat	Hot water heat				
					215°F factor of 1.00	190°F factor of 0.78	180°F factor of 0.69	170°F factor of 0.61	160°F factor of 0.53	
Copper element										
3/4" Dia. copper	3/4C-2 3/4 x 4-32	1	12	16	4.23	1016	790	700	620	540
		1	18	22	4.23	1016	790	700	620	540
		1	24	28	4.48	1076	840	740	660	570
		2	24	28	6.65	1597	1250	1100	970	850
	3/4C-2 3/4 x 4-40	1	12	16	5.00	1201	940	830	730	640
		1	18	22	5.00	1201	940	830	730	640
		1	24	28	5.47	1313	1020	910	800	700
		2	24	28	7.12	1709	1330	1180	1040	910
	3/4C-2 3/4 x 4-48	1	12	16	5.42	1300	1010	900	790	690
		1	18	22	5.42	1300	1010	900	790	690
		1	24	28	6.13	1472	1150	1020	900	780
		2	24	28	7.32	1756	1370	1210	1070	930
3/4" Dia. copper	3/4C-3 1/4 x 3 1/4-32	1	12	16	4.92	1180	920	810	720	630
		1	18	22	4.81	1155	900	800	700	610
		1	24	28	5.10	1223	950	840	750	650
		2	24	28	7.56	1815	1420	1250	1110	960
	3/4C-3 1/4 x 3 1/4-40	1	12	16	5.50	1320	1030	910	810	700
		1	18	22	5.69	1365	1060	940	830	720
		1	24	28	6.22	1493	1160	1030	910	790
		2	24	28	8.10	1943	1520	1340	1190	1030
	3/4C-3 1/4 x 3 1/4-48	1	12	16	6.00	1440	1120	990	880	760
		1	18	22	6.16	1478	1150	1020	900	780
		1	24	28	6.97	1673	1300	1150	1020	890
		2	24	28	8.31	1995	1560	1380	1220	1060

*EDR - Equivalent Direct Radiation area (for steam heat) per active (finned) lineal foot of tube.

Important rating information Performance ratings based on:

- Installation at height shown. (Lower heights are not recommended; for greater heights refer to EZselect selection software).
- Entering air temperature of 65°F. (For other temperatures, refer to EZselect selection software).

- Steam at nominal 1 (actual 0.9) psig and 215°F. (For other conditions, refer to EZselect selection software).
- Water average temperature (°F) shown and velocity of 3 fps or more. (For lower velocities, refer to EZselect selection software).

Enclosure Submittal Data

English, IP Units

General data

Performance ratings: model S-DSP5; perforated enclosure

In BTU/hr per active (finned) lineal foot of tube at entering air temperature of 65°F

Element	Rows of element (on 6-inch centers)	Enclosure height (in inches)	Recommended minimum installed height (in inches)	EDR* (ft ² /ft)	Steam heat	Hot water heat				
					215°F factor of 1.00	190°F factor of 0.78	180°F factor of 0.69	170°F factor of 0.61	160°F factor of 0.53	
Copper element										
¾" Dia. copper	¾C-4¼ x 4¼-32	1	12	16	6.42	1540	1200	1060	940	820
		1	18	22	6.42	1540	1200	1060	940	820
		1	24	28	6.79	1630	1270	1120	990	860
		2	24	28	10.08	2420	1890	1670	1480	1280
	¾C-4¼ x 4¼-40	1	12	16	7.58	1820	1420	1260	1110	960
		1	18	22	7.58	1820	1420	1260	1110	960
		1	24	28	8.29	1990	1550	1370	1210	1050
		2	24	28	10.79	2590	2020	1790	1580	1370
	¾C-4¼ x 4¼-48	1	12	16	8.21	1970	1540	1360	1200	1040
		1	18	22	8.21	1970	1540	1360	1200	1040
		1	24	28	9.29	2230	1740	1540	1360	1180
		2	24	28	11.08	2660	2070	1840	1620	1410
1" Dia. copper	1C-2¾ x 4-32	1	12	16	4.15	997	780	690	610	530
		1	18	22	4.15	997	780	690	610	530
		1	24	28	4.43	1063	830	730	650	560
		2	24	28	6.60	1584	1240	1090	970	840
	1C-2¾ x 4-40	1	12	16	4.90	1175	920	810	720	620
		1	18	22	4.90	1175	920	810	720	620
		1	24	28	5.33	1280	1000	880	780	680
		2	24	28	6.98	1676	1310	1160	1020	890
	1C-2¾ x 4-48	1	12	16	5.28	1267	990	870	770	670
		1	18	22	5.28	1267	990	870	770	670
		1	24	28	6.00	1439	1120	990	880	760
		2	24	28	7.20	1729	1350	1190	1050	920

*EDR - Equivalent Direct Radiation area (for steam heat) per active (finned) lineal foot of tube.

Important rating information Performance ratings based on:

- Installation at height shown. (Lower heights are not recommended; for greater heights refer to EZselect selection software).
- Entering air temperature of 65°F. (For other temperatures, refer to EZselect selection software).

- Steam at nominal 1 (actual 0.9) psig and 215°F. (For other conditions, refer to EZselect selection software).
- Water average temperature (°F) shown and velocity of 3 fps or more. (For lower velocities, refer to EZselect selection software).

Enclosure Submittal Data

English, IP Units

General data

Performance ratings: model S-DSP5; perforated enclosure

In BTU/hr per active (finned) lineal foot of tube at entering air temperature of 65°F

Element	Rows of element (on 6-inch centers)	Enclosure height (in inches)	Recommended minimum installed height (in inches)	EDR* (ft ² /ft)	Steam heat	Hot water heat				
					215°F factor of 1.00	190°F factor of 0.78	180°F factor of 0.69	170°F factor of 0.61	160°F factor of 0.53	
Copper element										
1" Dia. copper	1C-3 ¹ / ₄ x 3 ¹ / ₄ -32	1	12	16	4.79	1150	900	790	700	610
		1	18	22	4.72	1133	880	780	690	600
		1	24	28	5.03	1208	940	830	740	640
		2	24	28	7.50	1800	1400	1240	1100	950
	1C-3 ¹ / ₄ x 3 ¹ / ₄ -40	1	12	16	5.42	1300	1010	900	790	690
		1	18	22	5.56	1335	1040	920	810	710
		1	24	28	6.06	1455	1130	1000	890	770
		2	24	28	7.94	1905	1490	1310	1160	1010
	1C-3 ¹ / ₄ x 3 ¹ / ₄ -48	1	12	16	5.92	1420	1110	980	870	750
		1	18	22	6.00	1440	1120	990	880	760
		1	24	28	6.81	1635	1280	1130	1000	870
		2	24	28	8.19	1965	1530	1360	1200	1040
1" Dia. copper	1C-4 ¹ / ₄ x 4 ¹ / ₄ -32	1	12	16	6.29	1510	1180	1040	920	800
		1	18	22	6.29	1510	1180	1040	920	800
		1	24	28	6.71	1610	1260	1110	980	850
		2	24	28	10.00	2400	1870	1660	1460	1270
	1C-4 ¹ / ₄ x 4 ¹ / ₄ -40	1	12	16	7.42	1780	1390	1230	1090	940
		1	18	22	7.42	1780	1390	1230	1090	940
		1	24	28	8.08	1940	1510	1340	1180	1030
		2	24	28	10.58	2540	1980	1750	1550	1350
	1C-4 ¹ / ₄ x 4 ¹ / ₄ -48	1	12	16	8.00	1920	1500	1320	1170	1020
		1	18	22	8.00	1920	1500	1320	1170	1020
		1	24	28	9.08	2180	1700	1500	1330	1160
		2	24	28	10.92	2620	2040	1810	1600	1390

*EDR - Equivalent Direct Radiation area (for steam heat) per active (finned) lineal foot of tube.

Important rating information Performance ratings based on:

- Installation at height shown. (Lower heights are not recommended; for greater heights refer to EZselect selection software).
- Entering air temperature of 65°F. (For other temperatures, refer to EZselect selection software).

- Steam at nominal 1 (actual 0.9) psig and 215°F. (For other conditions, refer to EZselect selection software).
- Water average temperature (°F) shown and velocity of 3 fps or more. (For lower velocities, refer to EZselect selection software).

Enclosure Submittal Data

English, IP Units

General data

Performance ratings: model S-DSP5; perforated enclosure

In BTU/hr per active (finned) lineal foot of tube at entering air temperature of 65°F

Element	Rows of element (on 6-inch centers)	Enclosure height (in inches)	Recommended minimum installed height (in inches)	EDR* (ft ² /ft)	Steam heat	Hot water heat				
					215°F factor of 1.00	190°F factor of 0.78	180°F factor of 0.69	170°F factor of 0.61	160°F factor of 0.53	
Copper element										
1 1/4" Dia. copper	1 1/4C-2 3/4 x 4-32	1	12	16	4.10	983	770	680	600	520
		1	18	22	4.10	983	770	680	600	520
		1	24	28	4.35	1043	810	720	640	550
		2	24	28	6.46	1551	1210	1070	950	820
	1 1/4C-2 3/4 x 4-40	1	12	16	4.81	1155	900	800	700	610
		1	18	22	4.81	1155	900	800	700	610
		1	24	28	5.28	1267	990	870	770	670
		2	24	28	6.88	1650	1290	1140	1010	870
	1 1/4C-2 3/4 x 4-48	1	12	16	5.23	1254	980	870	760	660
		1	18	22	5.23	1254	980	870	760	660
		1	24	28	5.94	1426	1110	980	870	760
		2	24	28	7.07	1696	1320	1170	1030	900
1 1/4" Dia. copper	1 1/4C-3 1/4 x 3 1/4-32	1	12	16	4.50	1080	840	750	660	570
		1	18	22	6.21	1490	1160	1030	910	790
		1	24	28	6.58	1580	1230	1090	960	840
		2	24	28	9.79	2350	1830	1620	1430	1250
	1 1/4C-3 1/4 x 3 1/4-40	1	12	16	5.29	1270	990	880	770	670
		1	18	22	5.47	1313	1020	910	800	700
		1	24	28	6.00	1440	1120	990	880	760
		2	24	28	7.81	1875	1460	1290	1140	990
	1 1/4C-3 1/4 x 3 1/4-48	1	12	16	5.71	1370	1070	950	840	730
		1	18	22	5.94	1425	1110	980	870	760
		1	24	28	6.75	1620	1260	1120	990	860
		2	24	28	8.03	1928	1500	1330	1180	1020

*EDR - Equivalent Direct Radiation area (for steam heat) per active (finned) lineal foot of tube.

Important rating information Performance ratings based on:

- Installation at height shown. (Lower heights are not recommended; for greater heights refer to EZselect selection software).
- Entering air temperature of 65°F. (For other temperatures, refer to EZselect selection software).

- Steam at nominal 1 (actual 0.9) psig and 215°F. (For other conditions, refer to EZselect selection software).
- Water average temperature (°F) shown and velocity of 3 fps or more. (For lower velocities, refer to EZselect selection software).

Enclosure Submittal Data

English, IP Units

General data

Performance ratings: model S-DSP5; perforated enclosure

In BTU/hr per active (finned) lineal foot of tube at entering air temperature of 65°F

Element	Rows of element (on 6-inch centers)	Enclosure height (in inches)	Recommended minimum installed height (in inches)	EDR* (ft ² /ft)	Steam heat	Hot water heat				
					215°F factor of 1.00	190°F factor of 0.78	180°F factor of 0.69	170°F factor of 0.61	160°F factor of 0.53	
Copper element										
1 1/4" Dia. copper	1 1/4C-4 1/4 x 4 1/4-32	1	12	16	6.21	1490	1160	1030	910	790
		1	18	22	6.21	1490	1160	1030	910	790
		1	24	28	6.58	1580	1230	1090	960	840
		2	24	28	9.79	2350	1830	1620	1430	1250
	1 1/4C-4 1/4 x 4 1/4-40	1	12	16	7.29	1750	1370	1210	1070	930
		1	18	22	7.29	1750	1370	1210	1070	930
		1	24	28	8.00	1920	1500	1320	1170	1020
		2	24	28	10.42	2500	1950	1730	1530	1330
	1 1/4C-4 1/4 x 4 1/4-48	1	12	16	7.92	1900	1480	1310	1160	1010
		1	18	22	7.92	1900	1480	1310	1160	1010
		1	24	28	9.00	2160	1680	1490	1320	1140
		2	24	28	10.71	2570	2000	1770	1570	1360

*EDR - Equivalent Direct Radiation area (for steam heat) per active (finned) lineal foot of tube.

Important rating information Performance ratings based on:

- Installation at height shown. (Lower heights are not recommended; for greater heights refer to EZselect selection software).
- Entering air temperature of 65°F. (For other temperatures, refer to EZselect selection software).
- Steam at nominal 1 (actual 0.9) psig and 215°F. (For other conditions, refer to EZselect selection software).
- Water average temperature (°F) shown and velocity of 3 fps or more. (For lower velocities, refer to EZselect selection software).

Enclosure Submittal Data

English, IP Units

General data

Performance ratings: model PDS5; perforated enclosure

In BTU/hr per active (finned) lineal foot of tube at entering air temperature of 65°F

Element	Rows of element (on 6-inch centers)	Enclosure height (in inches)	Recommended minimum installed height (in inches)	EDR* (ft ² / ft)	Steam heat	Hot water heat				
					215°F factor of 1.00	190°F factor of 0.78	180°F factor of 0.69	170°F factor of 0.61	160°F factor of 0.53	
Steel element										
1" Dia. steel	1S-3¼ X 3¼-32	1	12	16	3.63	871	680	600	530	460
		1	18	22	3.82	917	720	630	560	490
		1	24	28	4.39	1053	820	730	640	560
		2	24	28	6.65	1595	1240	1100	970	850
	1S-3¼ X 3¼-40	1	12	16	4.02	964	750	670	590	510
		1	18	22	4.18	1004	780	690	610	530
		1	24	28	4.90	1176	920	810	720	620
		2	24	28	7.31	1755	1370	1210	1070	930
	1S-3¼ X 3¼-48	1	12	16	4.62	1109	870	770	680	590
		1	18	22	4.60	1104	860	760	670	590
		1	24	28	5.39	1293	1010	890	790	690
		2	24	28	8.04	1930	1510	1330	1180	1020
1" Dia. steel	1S-4¼ X 4¼-32	1	12	16	5.50	1320	1030	910	810	700
		1	18	22	5.10	1223	950	840	750	650
		1	24	28	5.85	1404	1100	970	860	740
		2	24	28	8.86	2126	1660	1470	1300	1130
	1S-4¼ X 4¼-40	1	12	16	6.08	1460	1140	1010	890	770
		1	18	22	5.58	1338	1040	920	820	710
		1	24	28	6.53	1568	1220	1080	960	830
		2	24	28	9.75	2340	1830	1610	1430	1240
	1S-4¼ X 4¼-48	1	12	16	7.00	1680	1310	1160	1020	890
		1	18	22	6.13	1472	1150	1020	900	780
		1	24	28	7.18	1724	1340	1190	1050	910
		2	24	28	10.73	2574	2010	1780	1570	1360

*EDR - Equivalent Direct Radiation area (for steam heat) per active (finned) lineal foot of tube.

Important rating information Performance ratings based on:

- Installation at height shown. (Lower heights are not recommended; for greater heights refer to EZselect selection software).
- Entering air temperature of 65°F. (For other temperatures, refer to EZselect selection software).

- Steam at nominal 1 (actual 0.9) psig and 215°F. (For other conditions, refer to EZselect selection software).
- Water average temperature (°F) shown and velocity of 3 fps or more. (For lower velocities, refer to EZselect selection software).

Enclosure Submittal Data

English, IP Units

General data

Performance ratings: model PDS5; perforated enclosure

In BTU/hr per active (finned) lineal foot of tube at entering air temperature of 65°F

Element	Rows of element (on 6-inch centers)	Enclosure height (in inches)	Recommended minimum installed height (in inches)	EDR* (ft ² / ft)	Steam heat	Hot water heat				
					215°F factor of 1.00	190°F factor of 0.78	180°F factor of 0.69	170°F factor of 0.61	160°F factor of 0.53	
Steel element										
1 1/4" Dia. steel	1 1/4S-3 1/4 X 3 1/4-32	1	12	16	3.71	890	690	610	540	470
		1	18	22	3.75	899	700	620	550	480
		1	24	28	4.30	1032	800	710	630	550
		2	24	28	6.52	1564	1220	1080	950	830
	1 1/4S-3 1/4 X 3 1/4-40	1	12	16	4.21	1010	790	700	620	540
		1	18	22	4.10	984	770	680	600	520
		1	24	28	4.80	1153	900	800	700	610
		2	24	28	7.17	1720	1340	1190	1050	910
	1 1/4S-3 1/4 X 3 1/4-48	1	12	16	4.71	1130	880	780	690	600
		1	18	22	4.51	1082	840	750	660	570
		1	24	28	5.28	1268	990	870	770	670
		2	24	28	7.88	1892	1480	1310	1150	1000
1 1/4" Dia. steel	1 1/4S-4 1/4 X 4 1/4-32	1	12	16	5.42	1300	1010	900	790	690
		1	18	22	5.00	1199	940	830	730	640
		1	24	28	5.74	1377	1070	950	840	730
		2	24	28	8.69	2085	1630	1440	1270	1110
	1 1/4S-4 1/4 X 4 1/4-40	1	12	16	6.08	1460	1140	1010	890	770
		1	18	22	5.47	1312	1020	910	800	700
		1	24	28	6.40	1537	1200	1060	940	810
		2	24	28	9.56	2294	1790	1580	1400	1220
	1 1/4S-4 1/4 X 4 1/4-48	1	12	16	6.79	1630	1270	1120	990	860
		1	18	22	6.01	1443	1130	1000	880	760
		1	24	28	7.05	1691	1320	1170	1030	900
		2	24	28	10.51	2523	1970	1740	1540	1340

*EDR - Equivalent Direct Radiation area (for steam heat) per active (finned) lineal foot of tube.

Important rating information Performance ratings based on:

- Installation at height shown. (Lower heights are not recommended; for greater heights refer to EZselect selection software).
- Entering air temperature of 65°F. (For other temperatures, refer to EZselect selection software).

- Steam at nominal 1 (actual 0.9) psig and 215°F. (For other conditions, refer to EZselect selection software).
- Water average temperature (°F) shown and velocity of 3 fps or more. (For lower velocities, refer to EZselect selection software).

Enclosure Submittal Data

English, IP Units

General data

Performance ratings: model PDS5; perforated enclosure

In BTU/hr per active (finned) lineal foot of tube at entering air temperature of 65°F

Element	Rows of element (on 6-inch centers)	Enclosure height (in inches)	Recommended minimum installed height (in inches)	EDR* (ft ² /ft)	Steam heat	Hot water heat				
					215°F factor of 1.00	190°F factor of 0.78	180°F factor of 0.69	170°F factor of 0.61	160°F factor of 0.53	
Steel element										
2" Dia. steel	2S-4¼ X 4¼-32	1	12	16	5.34	1281	1000	880	780	680
		1	18	22	4.91	1179	920	810	720	620
		1	24	28	5.69	1366	1070	940	830	720
		2	24	28	8.28	1986	1550	1370	1210	1050
	2S-4¼ X 4¼-40	1	12	16	5.99	1438	1120	990	880	760
		1	18	22	5.40	1297	1010	890	790	690
		1	24	28	6.26	1503	1170	1040	920	800
		2	24	28	9.10	2184	1700	1510	1330	1160
	2S-4¼ X 4¼-48	1	12	16	6.69	1606	1250	1110	980	850
		1	18	22	5.94	1426	1110	980	870	760
		1	24	28	6.89	1653	1290	1140	1010	880
		2	24	28	10.01	2402	1870	1660	1470	1270

*EDR - Equivalent Direct Radiation area (for steam heat) per active (finned) lineal foot of tube.

Important rating information Performance ratings based on:

- Installation at height shown. (Lower heights are not recommended; for greater heights refer to EZselect selection software).
- Entering air temperature of 65°F. (For other temperatures, refer to EZselect selection software).
- Steam at nominal 1 (actual 0.9) psig and 215°F. (For other conditions, refer to EZselect selection software).
- Water average temperature (°F) shown and velocity of 3 fps or more. (For lower velocities, refer to EZselect selection software).

Enclosure Submittal Data

English, IP Units

General data

Performance ratings: model PDS5; perforated enclosure

In BTU/hr per active (finned) lineal foot of tube at entering air temperature of 65°F

Element	Rows of element (on 6-inch centers)	Enclosure height (in inches)	Recommended minimum installed height (in inches)	EDR* (ft ² /ft)	Steam heat	Hot water heat				
					215°F factor of 1.00	190°F factor of 0.78	180°F factor of 0.69	170°F factor of 0.61	160°F factor of 0.53	
Copper element										
3/4" Dia. copper	3/4C-2 3/4 x 4-32	1	12	16	4.23	1016	790	700	620	540
		1	18	22	4.23	1016	790	700	620	540
		1	24	28	4.48	1076	840	740	660	570
		2	24	28	6.65	1597	1250	1100	970	850
	3/4C-2 3/4 x 4-40	1	12	16	5.00	1201	940	830	730	640
		1	18	22	5.00	1201	940	830	730	640
		1	24	28	5.47	1313	1020	910	800	700
		2	24	28	7.12	1709	1330	1180	1040	910
	3/4C-2 3/4 x 4-48	1	12	16	5.42	1300	1010	900	790	690
		1	18	22	5.42	1300	1010	900	790	690
		1	24	28	6.13	1472	1150	1020	900	780
		2	24	28	7.32	1756	1370	1210	1070	930
3/4" Dia. copper	3/4C-3 1/4 x 3 1/4-32	1	12	16	4.92	1180	920	810	720	630
		1	18	22	4.81	1155	900	800	700	610
		1	24	28	5.10	1223	950	840	750	650
		2	24	28	7.56	1815	1420	1250	1110	960
	3/4C-3 1/4 x 3 1/4-40	1	12	16	5.50	1320	1030	910	810	700
		1	18	22	5.69	1365	1060	940	830	720
		1	24	28	6.22	1493	1160	1030	910	790
		2	24	28	8.10	1943	1520	1340	1190	1030
	3/4C-3 1/4 x 3 1/4-48	1	12	16	6.00	1440	1120	990	880	760
		1	18	22	6.16	1478	1150	1020	900	780
		1	24	28	6.97	1673	1300	1150	1020	890
		2	24	28	8.31	1995	1560	1380	1220	1060

*EDR - Equivalent Direct Radiation area (for steam heat) per active (finned) lineal foot of tube.

Important rating information Performance ratings based on:

- Installation at height shown. (Lower heights are not recommended; for greater heights refer to EZselect selection software).
- Entering air temperature of 65°F. (For other temperatures, refer to EZselect selection software).

- Steam at nominal 1 (actual 0.9) psig and 215°F. (For other conditions, refer to EZselect selection software).
- Water average temperature (°F) shown and velocity of 3 fps or more. (For lower velocities, refer to EZselect selection software).

Enclosure Submittal Data

English, IP Units

General data

Performance ratings: model PDS5; perforated enclosure

In BTU/hr per active (finned) lineal foot of tube at entering air temperature of 65°F

Element	Rows of element (on 6-inch centers)	Enclosure height (in inches)	Recommended minimum installed height (in inches)	EDR* (ft ² /ft)	Steam heat	Hot water heat				
					215°F factor of 1.00	190°F factor of 0.78	180°F factor of 0.69	170°F factor of 0.61	160°F factor of 0.53	
Copper element										
¾" Dia. copper	¾C-4¼ x 4¼-32	1	12	16	6.42	1540	1200	1060	940	820
		1	18	22	6.42	1540	1200	1060	940	820
		1	24	28	6.79	1630	1270	1120	990	860
		2	24	28	10.08	2420	1890	1670	1480	1280
	¾C-4¼ x 4¼-40	1	12	16	7.58	1820	1420	1260	1110	960
		1	18	22	7.58	1820	1420	1260	1110	960
		1	24	28	8.29	1990	1550	1370	1210	1050
		2	24	28	10.79	2590	2020	1790	1580	1370
	¾C-4¼ x 4¼-48	1	12	16	8.21	1970	1540	1360	1200	1040
		1	18	22	8.21	1970	1540	1360	1200	1040
		1	24	28	9.29	2230	1740	1540	1360	1180
		2	24	28	11.08	2660	2070	1840	1620	1410
1" Dia. copper	1C-2¾ x 4-32	1	12	16	4.15	997	780	690	610	530
		1	18	22	4.15	997	780	690	610	530
		1	24	28	4.43	1063	830	730	650	560
		2	24	28	6.60	1584	1240	1090	970	840
	1C-2¾ x 4-40	1	12	16	4.90	1175	920	810	720	620
		1	18	22	4.90	1175	920	810	720	620
		1	24	28	5.33	1280	1000	880	780	680
		2	24	28	6.98	1676	1310	1160	1020	890
	1C-2¾ x 4-48	1	12	16	5.28	1267	990	870	770	670
		1	18	22	5.28	1267	990	870	770	670
		1	24	28	6.00	1439	1120	990	880	760
		2	24	28	7.20	1729	1350	1190	1050	920

*EDR - Equivalent Direct Radiation area (for steam heat) per active (finned) lineal foot of tube.

Important rating information Performance ratings based on:

- Installation at height shown. (Lower heights are not recommended; for greater heights refer to EZselect selection software).
- Entering air temperature of 65°F. (For other temperatures, refer to EZselect selection software).
- Steam at nominal 1 (actual 0.9) psig and 215°F. (For other conditions, refer to EZselect selection software).
- Water average temperature (°F) shown and velocity of 3 fps or more. (For lower velocities, refer to EZselect selection software).

Enclosure Submittal Data

English, IP Units

General data

Performance ratings: model PDS5; perforated enclosure

In BTU/hr per active (finned) lineal foot of tube at entering air temperature of 65°F

Element	Rows of element (on 6-inch centers)	Enclosure height (in inches)	Recommended minimum installed height (in inches)	EDR* (ft ² /ft)	Steam heat	Hot water heat				
					215°F factor of 1.00	190°F factor of 0.78	180°F factor of 0.69	170°F factor of 0.61	160°F factor of 0.53	
Copper element										
1" Dia. copper	1C-3¼ x 3¼-32	1	12	16	4.79	1150	900	790	700	610
		1	18	22	4.72	1133	880	780	690	600
		1	24	28	5.03	1208	940	830	740	640
		2	24	28	7.50	1800	1400	1240	1100	950
	1C-3¼ x 3¼-40	1	12	16	5.42	1300	1010	900	790	690
		1	18	22	5.56	1335	1040	920	810	710
		1	24	28	6.06	1455	1130	1000	890	770
		2	24	28	7.94	1905	1490	1310	1160	1010
	1C-3¼ x 3¼-48	1	12	16	5.92	1420	1110	980	870	750
		1	18	22	6.00	1440	1120	990	880	760
		1	24	28	6.81	1635	1280	1130	1000	870
		2	24	28	8.19	1965	1530	1360	1200	1040
1" Dia. copper	1C-4¼ x 4¼-32	1	12	16	6.29	1510	1180	1040	920	800
		1	18	22	6.29	1510	1180	1040	920	800
		1	24	28	6.71	1610	1260	1110	980	850
		2	24	28	10.00	2400	1870	1660	1460	1270
	1C-4¼ x 4¼-40	1	12	16	7.42	1780	1390	1230	1090	940
		1	18	22	7.42	1780	1390	1230	1090	940
		1	24	28	8.08	1940	1510	1340	1180	1030
		2	24	28	10.58	2540	1980	1750	1550	1350
	1C-4¼ x 4¼-48	1	12	16	8.00	1920	1500	1320	1170	1020
		1	18	22	8.00	1920	1500	1320	1170	1020
		1	24	28	9.08	2180	1700	1500	1330	1160
		2	24	28	10.92	2620	2040	1810	1600	1390

*EDR - Equivalent Direct Radiation area (for steam heat) per active (finned) lineal foot of tube.

Important rating information Performance ratings based on:

- Installation at height shown. (Lower heights are not recommended; for greater heights refer to EZselect selection software).
- Entering air temperature of 65°F. (For other temperatures, refer to EZselect selection software).

- Steam at nominal 1 (actual 0.9) psig and 215°F. (For other conditions, refer to EZselect selection software).
- Water average temperature (°F) shown and velocity of 3 fps or more. (For lower velocities, refer to EZselect selection software).

Enclosure Submittal Data

English, IP Units

General data

Performance ratings: model PDS5; perforated enclosure

In BTU/hr per active (finned) lineal foot of tube at entering air temperature of 65°F

Element	Rows of element (on 6-inch centers)	Enclosure height (in inches)	Recommended minimum installed height (in inches)	EDR* (ft ² /ft)	Steam heat	Hot water heat				
					215°F factor of 1.00	190°F factor of 0.78	180°F factor of 0.69	170°F factor of 0.61	160°F factor of 0.53	
Copper element										
1 1/4" Dia. copper	1 1/4C-2 3/4 x 4-32	1	12	16	4.10	983	770	680	600	520
		1	18	22	4.10	983	770	680	600	520
		1	24	28	4.35	1043	810	720	640	550
		2	24	28	6.46	1551	1210	1070	950	820
	1 1/4C-2 3/4 x 4-40	1	12	16	4.81	1155	900	800	700	610
		1	18	22	4.81	1155	900	800	700	610
		1	24	28	5.28	1267	990	870	770	670
		2	24	28	6.88	1650	1290	1140	1010	870
	1 1/4C-2 3/4 x 4-48	1	12	16	5.23	1254	980	870	760	660
		1	18	22	5.23	1254	980	870	760	660
		1	24	28	5.94	1426	1110	980	870	760
		2	24	28	7.07	1696	1320	1170	1030	900
1 1/4" Dia. copper	1 1/4C-3 1/4 x 3 1/4-32	1	12	16	4.50	1080	840	750	660	570
		1	18	22	4.66	1118	870	770	680	590
		1	24	28	4.94	1185	920	820	720	630
		2	24	28	7.35	1763	1380	1220	1080	930
	1 1/4C-3 1/4 x 3 1/4-40	1	12	16	5.29	1270	990	880	770	670
		1	18	22	5.47	1313	1020	910	800	700
		1	24	28	6.00	1440	1120	990	880	760
		2	24	28	7.81	1875	1460	1290	1140	990
	1 1/4C-3 1/4 x 3 1/4-48	1	12	16	5.71	1370	1070	950	840	730
		1	18	22	5.94	1425	1110	980	870	760
		1	24	28	6.75	1620	1260	1120	990	860
		2	24	28	8.03	1928	1500	1330	1180	1020

*EDR - Equivalent Direct Radiation area (for steam heat) per active (finned) lineal foot of tube.

Important rating information Performance ratings based on:

- Installation at height shown. (Lower heights are not recommended; for greater heights refer to EZselect selection software).
- Entering air temperature of 65°F. (For other temperatures, refer to EZselect selection software).

- Steam at nominal 1 (actual 0.9) psig and 215°F. (For other conditions, refer to EZselect selection software).
- Water average temperature (°F) shown and velocity of 3 fps or more. (For lower velocities, refer to EZselect selection software).

Enclosure Submittal Data

English, IP Units

General data

Performance ratings: model PDS5; perforated enclosure

In BTU/hr per active (finned) lineal foot of tube at entering air temperature of 65°F

Element	Rows of element (on 6-inch centers)	Enclosure height (in inches)	Recommended minimum installed height (in inches)	EDR* (ft ² /ft)	Steam heat	Hot water heat				
					215°F factor of 1.00	190°F factor of 0.78	180°F factor of 0.69	170°F factor of 0.61	160°F factor of 0.53	
Copper element										
1 1/4" Dia. copper	1 1/4C-4 1/4 x 4 1/4-32	1	12	16	6.21	1490	1160	1030	910	790
		1	18	22	6.21	1490	1160	1030	910	790
		1	24	28	6.58	1580	1230	1090	960	840
		2	24	28	9.79	2350	1830	1620	1430	1250
	1 1/4C-4 1/4 x 4 1/4-40	1	12	16	7.29	1750	1370	1210	1070	930
		1	18	22	7.29	1750	1370	1210	1070	930
		1	24	28	8.00	1920	1500	1320	1170	1020
		2	24	28	10.42	2500	1950	1730	1530	1330
	1 1/4C-4 1/4 x 4 1/4-48	1	12	16	7.92	1900	1480	1310	1160	1010
		1	18	22	7.92	1900	1480	1310	1160	1010
		1	24	28	9.00	2160	1680	1490	1320	1140
		2	24	28	10.71	2570	2000	1770	1570	1360

*EDR - Equivalent Direct Radiation area (for steam heat) per active (finned) lineal foot of tube.

Important rating information Performance ratings based on:

- Installation at height shown. (Lower heights are not recommended; for greater heights refer to EZselect selection software).
- Entering air temperature of 65°F. (For other temperatures, refer to EZselect selection software).
- Steam at nominal 1 (actual 0.9) psig and 215°F. (For other conditions, refer to EZselect selection software).
- Water average temperature (°F) shown and velocity of 3 fps or more. (For lower velocities, refer to EZselect selection software).

Enclosure Submittal Data

English, IP Units

General data

Performance ratings: model S-TP5/PR5; perforated enclosure

In BTU/hr per active (finned) lineal foot of tube at entering air temperature of 65°F

Element	Rows of element (on 6-inch centers)	Enclosure height (in inches)	Recommended minimum installed height (in inches)	EDR* (ft ² /ft)	Steam heat	Hot water heat					
					215°F factor of 1.00	190°F factor of 0.78	180°F factor of 0.69	170°F factor of 0.61	160°F factor of 0.53		
Steel element											
1" Dia. steel	1S-3¼ X 3¼-32	1	12	16	3.6	867	676	598	529	460	
		1	18	22	3.8	905	706	624	552	480	
		2	18	22	5.5	1314	1025	907	801	696	
		1	24	28	3.8	924	720	637	563	490	
		2	24	28	5.8	1389	1083	958	847	736	
		3	24	28	6.5	1563	1219	1079	954	829	
	1S-3¼ X 3¼-40	1	12	16	3.9	946	738	652	577	501	
		1	18	22	4.2	1020	795	704	622	540	
		2	18	22	6.3	1504	1173	1038	917	797	
		1	24	28	4.4	1057	824	729	645	560	
		2	24	28	6.5	1562	1218	1078	953	828	
	1S-3¼ X 3¼-48	1	12	16	4.4	1067	832	736	651	565	
		1	18	22	4.9	1177	918	812	718	624	
		2	18	22	7.1	1707	1331	1177	1041	904	
		1	24	28	5.1	1214	947	838	741	643	
		2	24	28	7.4	1766	1378	1219	1077	936	
	1" Dia. steel	1S-4¼ X 4¼-32	1	12	16	4.6	1115	870	769	680	591
			1	18	22	4.8	1164	908	803	710	617
2			18	22	7.1	1697	1324	1171	1035	899	
1			24	28	4.9	1188	926	820	725	630	
2			24	28	7.5	1794	1399	1238	1094	951	
3			24	28	8.6	2060	1607	1422	1257	1092	
1S-4¼ X 4¼-40		1	12	16	5.2	1236	964	853	754	655	
		1	18	22	5.6	1333	1040	920	813	707	
		2	18	22	7.9	1891	1475	1305	1153	1002	
		1	24	28	5.8	1382	1078	953	843	732	
		2	24	28	8.2	1963	1531	1355	1198	1041	
1S-4¼ X 4¼-48		1	12	16	5.9	1406	1097	970	858	745	
		1	18	22	6.5	1551	1210	1070	946	822	
		2	18	22	8.7	2085	1626	1438	1272	1105	
		1	24	28	6.7	1600	1248	1104	976	848	
		2	24	28	9.0	2157	1683	1489	1316	1143	
		3	24	28	10.4	2497	1947	1723	1523	1323	

*EDR - Equivalent Direct Radiation area (for steam heat) per active (finned) lineal foot of tube.

Important rating information Performance ratings based on:

- Installation at height shown. (Lower heights are not recommended; for greater heights refer to EZselect selection software).
- Entering air temperature of 65°F. (For other temperatures, refer to EZselect selection software).

- Steam at nominal 1 (actual 0.9) psig and 215°F. (For other conditions, refer to EZselect selection software).
- Water average temperature (°F) shown and velocity of 3 fps or more. (For lower velocities, refer to EZselect selection software).

Revised February 2016. Zehnder periodically makes changes to the design and/or specifications of its products. As a result, the design and specifications of each product at the time of order may be different than as described herein. Please contact Zehnder's Sales Support staff at 844-934-6337 for specific information on current design and specifications. Designs, specifications and other information contained herein are not express warranties, which are only as expressly set forth by Zehnder in its terms and conditions of sale. The latest version of this document is available at www.zehnder-ritting.com.

Enclosure Submittal Data

English, IP Units

General data

Performance ratings: model S-TP5/PR5; perforated enclosure

In BTU/hr per active (finned) lineal foot of tube at entering air temperature of 65°F

Element	Rows of element (on 6-inch centers)	Enclosure height (in inches)	Recommended minimum installed height (in inches)	EDR* (ft ² /ft)	Steam heat	Hot water heat				
					215°F factor of 1.00	190°F factor of 0.78	180°F factor of 0.69	170°F factor of 0.61	160°F factor of 0.53	
Steel element										
1 1/4" Dia. steel	1 1/4S-3 1/4 X 3 1/4-32	1	12	16	3.5	850	663	587	519	451
		1	18	22	3.7	887	692	612	541	470
		2	18	22	5.5	1327	1035	916	810	703
		1	24	28	3.8	906	706	625	552	480
		2	24	28	5.8	1403	1094	968	856	744
		3	24	28	6.7	1612	1257	1112	983	854
	1 1/4S-3 1/4 X 3 1/4-40	1	12	16	3.8	918	716	633	560	487
		1	18	22	4.1	990	772	683	604	525
		2	18	22	6.1	1460	1139	1008	891	774
		1	24	28	4.3	1026	800	708	626	544
		2	24	28	6.3	1516	1183	1046	925	804
		3	24	28	7.4	1786	1393	1232	1089	946
	1 1/4S-3 1/4 X 3 1/4-48	1	12	16	4.2	1016	793	701	620	539
		1	18	22	4.7	1121	875	774	684	594
		2	18	22	6.7	1610	1256	1111	982	853
		1	24	28	4.8	1156	902	798	705	613
		2	24	28	6.9	1666	1300	1150	1016	883
		3	24	28	8.3	2002	1562	1382	1221	1061
1 1/4" Dia. steel	1 1/4S-4 1/4 X 4 1/4-32	1	12	16	4.6	1110	860	760	670	580
		1	18	22	4.8	1140	890	790	700	600
		2	18	22	7	1690	1320	1170	1030	900
		1	24	28	4.9	1170	910	810	710	620
		2	24	28	7.4	1770	1380	1220	1080	940
		3	24	28	8.5	2030	1580	1400	1240	1080
	1 1/4S-4 1/4 X 4 1/4-40	1	12	16	5.1	1230	960	850	750	650
		1	18	22	5.5	1330	1040	920	810	700
		2	18	22	7.8	1860	1450	1280	1130	990
		1	24	28	5.7	1360	1060	940	830	720
		2	24	28	8.1	1940	1510	1340	1180	1030
		3	24	28	9.3	2220	1730	1530	1350	1180
	1 1/4S-4 1/4 X 4 1/4-48	1	12	16	5.8	1380	1080	950	840	730
		1	18	22	6.4	1540	1200	1060	940	820
		2	18	22	8.6	2060	1610	1420	1260	1090
		1	24	28	6.6	1580	1230	1090	960	840
		2	24	28	8.9	2130	1660	1470	1300	1130
		3	24	28	10.3	2460	1920	1700	1500	1300

*EDR - Equivalent Direct Radiation area (for steam heat) per active (finned) lineal foot of tube.

Important rating information Performance ratings based on:

- Installation at height shown. (Lower heights are not recommended; for greater heights refer to EZselect selection software).
- Entering air temperature of 65°F. (For other temperatures, refer to EZselect selection software).

- Steam at nominal 1 (actual 0.9) psig and 215°F. (For other conditions, refer to EZselect selection software).
- Water average temperature (°F) shown and velocity of 3 fps or more. (For lower velocities, refer to EZselect selection software).

Revised February 2016. Zehnder periodically makes changes to the design and/or specifications of its products. As a result, the design and specifications of each product at the time of order may be different than as described herein. Please contact Zehnder's Sales Support staff at 844-934-6337 for specific information on current design and specifications. Designs, specifications and other information contained herein are not express warranties, which are only as expressly set forth by Zehnder in its terms and conditions of sale. The latest version of this document is available at www.zehnder-ritting.com.

Enclosure Submittal Data

English, IP Units

General data

Performance ratings: model S-TP5/PR5; perforated enclosure

In BTU/hr per active (finned) lineal foot of tube at entering air temperature of 65°F

Element	Rows of element (on 6-inch centers)	Enclosure height (in inches)	Recommended minimum installed height (in inches)	EDR* (ft ² /ft)	Steam heat	Hot water heat				
					215°F factor of 1.00	190°F factor of 0.78	180°F factor of 0.69	170°F factor of 0.61	160°F factor of 0.53	
Steel element										
2" Dia. steel	2S-4¼ X 4¼-32	1	12	16	4.4	1060	827	731	647	562
		1	18	22	4.6	1106	863	763	675	586
		2	18	22	6.8	1630	1271	1124	994	864
		1	24	28	4.7	1129	881	779	689	598
		2	24	28	7.2	1723	1344	1189	1051	913
		3	24	28	8.2	1979	1543	1365	1207	1049
	2S-4¼ X 4¼-40	1	12	16	4.9	1187	926	819	724	629
		1	18	22	5.3	1280	999	883	781	679
		2	18	22	7.5	1797	1402	1240	1096	952
		1	24	28	5.5	1327	1035	916	809	703
		2	24	28	7.8	1866	1456	1288	1138	989
		3	24	28	8.8	2120	1654	1463	1293	1124
	2S-4¼ X 4¼-48	1	12	16	5.6	1350	1053	932	824	716
		1	18	22	6.2	1490	1162	1028	909	790
		2	18	22	8.2	1961	1529	1353	1196	1039
		1	24	28	6.4	1536	1198	1060	937	814
		2	24	28	8.5	2029	1583	1400	1238	1075
		3	24	28	9.7	2324	1812	1603	1417	1232

*EDR - Equivalent Direct Radiation area (for steam heat) per active (finned) lineal foot of tube.

Important rating information Performance ratings based on:

- Installation at height shown. (Lower heights are not recommended; for greater heights refer to EZselect selection software).
- Entering air temperature of 65°F. (For other temperatures, refer to EZselect selection software).
- Steam at nominal 1 (actual 0.9) psig and 215°F. (For other conditions, refer to EZselect selection software).
- Water average temperature (°F) shown and velocity of 3 fps or more. (For lower velocities, refer to EZselect selection software).

Enclosure Submittal Data

English, IP Units

General data

Performance ratings: model S-TP5/PR5; perforated enclosure

In BTU/hr per active (finned) lineal foot of tube at entering air temperature of 65°F

Element	Rows of element (on 6-inch centers)	Enclosure height (in inches)	Recommended minimum installed height (in inches)	EDR* (ft ² /ft)	Steam heat	Hot water heat				
					215°F factor of 1.00	190°F factor of 0.78	180°F factor of 0.69	170°F factor of 0.61	160°F factor of 0.53	
Copper element										
3/4" Dia. copper	3/4C-2 3/4 x 4-32	1	12	16	4.3	1037	809	715	632	550
		1	18	22	4.6	1114	869	768	679	590
		2	18	22	7.3	1754	1368	1211	1070	930
		1	24	28	4.9	1171	914	808	714	621
		2	24	28	8.2	1961	1529	1353	1196	1039
		3	24	28	9.7	2323	1812	1603	1417	1231
	3/4C-2 3/4 x 4-40	1	12	16	5.2	1240	967	855	756	657
		1	18	22	5.7	1358	1059	937	828	720
		2	18	22	8.2	1965	1533	1356	1199	1042
		1	24	28	6.0	1437	1121	991	876	761
		2	24	28	9.2	2200	1716	1518	1342	1166
		3	24	28	10.9	2605	2032	1798	1589	1381
	3/4C-2 3/4 x 4-48	1	12	16	5.4	1299	1013	896	792	688
		1	18	22	6.2	1496	1167	1032	912	793
		2	18	22	8.1	1943	1516	1341	1185	1030
		1	24	28	7.1	1692	1320	1168	1032	897
		2	24	28	9.5	2274	1774	1569	1387	1205
		3	24	28	11.4	2747	2143	1895	1676	1456
3/4" Dia. copper	3/4C-3 1/4 x 3 1/4-32	1	12	16	4.1	972	758	671	593	515
		1	18	22	4.4	1044	814	720	637	553
		2	18	22	6.7	1612	1257	1112	983	854
		1	24	28	4.6	1098	856	758	670	582
		2	24	28	7.5	1801	1405	1243	1099	955
		3	24	28	8.8	2112	1647	1457	1288	1119
	3/4C-3 1/4 x 3 1/4-40	1	12	16	4.7	1134	885	782	692	601
		1	18	22	5.2	1242	969	857	758	658
		2	18	22	7.4	1766	1378	1219	1078	936
		1	24	28	5.5	1314	1025	907	802	696
		2	24	28	8.2	1978	1543	1365	1206	1048
		3	24	28	9.7	2322	1811	1602	1417	1231
	3/4C-3 1/4 x 3 1/4-48	1	12	16	5.0	1188	927	820	725	630
		1	18	22	5.7	1368	1067	944	834	725
		2	18	22	7.1	1711	1334	1180	1044	907
		1	24	28	6.5	1548	1207	1068	944	820
		2	24	28	8.3	2002	1562	1382	1221	1061
		3	24	28	9.9	2379	1856	1641	1451	1261

*EDR - Equivalent Direct Radiation area (for steam heat) per active (finned) lineal foot of tube.

Important rating information Performance ratings based on:

- Installation at height shown. (Lower heights are not recommended; for greater heights refer to EZselect selection software).
- Entering air temperature of 65°F. (For other temperatures, refer to EZselect selection software).

- Steam at nominal 1 (actual 0.9) psig and 215°F. (For other conditions, refer to EZselect selection software).
- Water average temperature (°F) shown and velocity of 3 fps or more. (For lower velocities, refer to EZselect selection software).

Revised February 2016. Zehnder periodically makes changes to the design and/or specifications of its products. As a result, the design and specifications of each product at the time of order may be different than as described herein. Please contact Zehnder's Sales Support staff at 844-934-6337 for specific information on current design and specifications. Designs, specifications and other information contained herein are not express warranties, which are only as expressly set forth by Zehnder in its terms and conditions of sale. The latest version of this document is available at www.zehnder-ritting.com.

Enclosure Submittal Data

English, IP Units

General data

Performance ratings: model S-TP5/PR5; perforated enclosure

In BTU/hr per active (finned) lineal foot of tube at entering air temperature of 65°F

Element	Rows of element (on 6-inch centers)	Enclosure height (in inches)	Recommended minimum installed height (in inches)	EDR* (ft ² /ft)	Steam heat	Hot water heat				
					215°F factor of 1.00	190°F factor of 0.78	180°F factor of 0.69	170°F factor of 0.61	160°F factor of 0.53	
Copper element										
3/4" Dia. copper	3/4C-4 1/4 x 4 1/4-32	1	12	16	5.4	1290	1010	890	790	680
		1	18	22	5.8	1390	1080	960	850	740
		2	18	22	8.5	2040	1590	1410	1240	1080
		1	24	28	6.1	1470	1150	1010	900	780
		2	24	28	9.5	2290	1790	1580	1400	1210
		3	24	28	11	2630	2050	1810	1600	1390
	3/4C-4 1/4 x 4 1/4-40	1	12	16	6.3	1510	1180	1040	920	800
		1	18	22	6.9	1640	1280	1130	1000	870
		2	18	22	9.2	2200	1720	1520	1340	1170
		1	24	28	7.3	1760	1370	1210	1070	930
		2	24	28	10.3	2470	1930	1700	1510	1310
		3	24	28	11.8	2840	2220	1960	1730	1510
	3/4C-4 1/4 x 4 1/4-48	1	12	16	6.6	1590	1240	1100	970	840
		1	18	22	7.6	1830	1430	1260	1120	970
		2	18	22	8.8	2120	1650	1460	1290	120
		1	24	28	8.6	2060	1610	1420	1260	1090
		2	24	28	10.3	2470	1930	1700	1510	1310
		3	24	28	11.8	2830	2210	1950	1730	1500
1" Dia. copper	1C-2 3/4 x 4-32	1	12	16	4.0	968	755	668	590	513
		1	18	22	4.3	1020	796	704	622	541
		2	18	22	6.1	1465	1143	1011	894	776
		1	24	28	4.4	1046	816	722	638	555
		2	24	28	7.0	1674	1306	1155	1021	887
		3	24	28	8.3	1998	1558	1379	1219	1059
	1C-2 3/4 x 4-40	1	12	16	5.1	1220	952	842	744	647
		1	18	22	5.5	1329	1037	917	811	704
		2	18	22	7.2	1716	1338	1184	1047	909
		1	24	28	6.0	1437	1121	992	877	762
		2	24	28	8.0	1927	1503	1330	1176	1021
		3	24	28	9.5	2271	1771	1567	1385	1204
	1C-2 3/4 x 4-48	1	12	16	5.2	1258	981	868	768	667
		1	18	22	6.0	1438	1122	992	877	762
		2	18	22	7.2	1736	1354	1198	1059	920
		1	24	28	6.6	1592	1242	1099	971	844
		2	24	28	8.5	2034	1587	1403	1241	1078
		3	24	28	10.1	2422	1889	1671	1477	1284

*EDR - Equivalent Direct Radiation area (for steam heat) per active (finned) lineal foot of tube.

Important rating information Performance ratings based on:

- Installation at height shown. (Lower heights are not recommended; for greater heights refer to EZselect selection software).
- Entering air temperature of 65°F. (For other temperatures, refer to EZselect selection software).

- Steam at nominal 1 (actual 0.9) psig and 215°F. (For other conditions, refer to EZselect selection software).
- Water average temperature (°F) shown and velocity of 3 fps or more. (For lower velocities, refer to EZselect selection software).

Revised February 2016. Zehnder periodically makes changes to the design and/or specifications of its products. As a result, the design and specifications of each product at the time of order may be different than as described herein. Please contact Zehnder's Sales Support staff at 844-934-6337 for specific information on current design and specifications. Designs, specifications and other information contained herein are not express warranties, which are only as expressly set forth by Zehnder in its terms and conditions of sale. The latest version of this document is available at www.zehnder-ritting.com.

Enclosure Submittal Data

English, IP Units

General data

Performance ratings: model S-TP5/PR5; perforated enclosure

In BTU/hr per active (finned) lineal foot of tube at entering air temperature of 65°F

Element	Rows of element (on 6-inch centers)	Enclosure height (in inches)	Recommended minimum installed height (in inches)	EDR* (ft ² /ft)	Steam heat	Hot water heat				
					215°F factor of 1.00	190°F factor of 0.78	180°F factor of 0.69	170°F factor of 0.61	160°F factor of 0.53	
Copper element										
1" Dia. copper	1C-3 ¹ / ₄ x 3 ¹ / ₄ -32	1	12	16	3.7	880	690	610	540	470
		1	18	22	3.9	930	730	640	570	490
		2	18	22	5.6	1360	1060	940	830	720
		1	24	28	4	990	770	680	600	520
		2	24	28	6.4	1540	1200	1060	940	820
		3	24	28	7.5	1790	1400	1240	1090	950
	1C-3 ¹ / ₄ x 3 ¹ / ₄ -40	1	12	16	4.5	1070	830	740	650	570
		1	18	22	4.9	1170	910	810	710	620
		2	18	22	6.5	1560	1220	1080	950	830
		1	24	28	5.3	1280	1000	880	780	680
		2	24	28	7.3	1740	1360	1200	1060	920
		3	24	28	8.3	2000	1560	1380	1220	1060
	1C-3 ¹ / ₄ x 3 ¹ / ₄ -48	1	12	16	4.9	1170	910	810	710	620
		1	18	22	5.6	1350	1050	930	820	720
		2	18	22	6.4	1540	1200	1060	940	820
		1	24	28	6.2	1490	1160	1030	910	790
		2	24	28	7.5	1810	1410	1250	1100	960
		3	24	28	8.7	2080	1620	1430	1270	1100
1" Dia. copper	1C-4 ¹ / ₄ x 4 ¹ / ₄ -32	1	12	16	5.3	1270	990	880	780	670
		1	18	22	5.7	1360	1060	940	830	720
		2	18	22	8.3	2000	1560	1380	1220	1060
		1	24	28	6	1440	1120	990	880	760
		2	24	28	9.4	2250	1760	1550	1370	1190
		3	24	28	10.8	2580	2010	1780	1570	1370
	1C-4 ¹ / ₄ x 4 ¹ / ₄ -40	1	12	16	6.2	1480	1150	1020	900	780
		1	18	22	6.7	1610	1260	1110	980	850
		2	18	22	9	2160	1690	1490	1320	1150
		1	24	28	7.2	1730	1350	1190	1060	920
		2	24	28	10.1	2420	1890	1670	1480	1280
		3	24	28	11.6	2780	2170	1920	1700	1470
	1C-4 ¹ / ₄ x 4 ¹ / ₄ -48	1	12	16	6.5	1560	1220	1080	950	830
		1	18	22	7.5	1790	1400	1240	1090	950
		2	18	22	8.7	2080	1620	1440	1270	110
		1	24	28	8.4	2020	1580	1390	1230	1070
		2	24	28	10.8	2600	2020	1790	1580	1370
		3	24	28	12.4	2980	2320	2050	1820	1580

*EDR - Equivalent Direct Radiation area (for steam heat) per active (finned) lineal foot of tube.

Important rating information Performance ratings based on:

- Installation at height shown. (Lower heights are not recommended; for greater heights refer to EZselect selection software).
- Entering air temperature of 65°F. (For other temperatures, refer to EZselect selection software).

- Steam at nominal 1 (actual 0.9) psig and 215°F. (For other conditions, refer to EZselect selection software).
- Water average temperature (°F) shown and velocity of 3 fps or more. (For lower velocities, refer to EZselect selection software).

Revised February 2016. Zehnder periodically makes changes to the design and/or specifications of its products. As a result, the design and specifications of each product at the time of order may be different than as described herein. Please contact Zehnder's Sales Support staff at 844-934-6337 for specific information on current design and specifications. Designs, specifications and other information contained herein are not express warranties, which are only as expressly set forth by Zehnder in its terms and conditions of sale. The latest version of this document is available at www.zehnder-ritting.com.

Enclosure Submittal Data

English, IP Units

General data

Performance ratings: model S-TP5/PR5; perforated enclosure

In BTU/hr per active (finned) lineal foot of tube at entering air temperature of 65°F

Element	Rows of element (on 6-inch centers)	Enclosure height (in inches)	Recommended minimum installed height (in inches)	EDR* (ft ² /ft)	Steam heat	Hot water heat				
					215°F factor of 1.00	190°F factor of 0.78	180°F factor of 0.69	170°F factor of 0.61	160°F factor of 0.53	
Copper element										
1 1/4" Dia. copper	1 1/4C-2 3/4 x 4-32	1	12	16	4.1	992	774	685	605	526
		1	18	22	4.3	1030	803	710	628	546
		2	18	22	6.6	1574	1228	1086	960	834
		1	24	28	4.6	1104	861	762	674	585
		2	24	28	7.6	1824	1423	1259	1113	967
		3	24	28	8.8	2112	1647	1457	1288	1119
	1 1/4C-2 3/4 x 4-40	1	12	16	4.9	1181	921	815	720	626
		1	18	22	5.4	1299	1013	896	792	688
		2	18	22	7.4	1773	1383	1223	1081	940
		1	24	28	5.8	1397	1090	964	852	741
		2	24	28	8.3	1992	1554	1374	1215	1056
		3	24	28	9.9	2380	1857	1642	1452	1262
	1 1/4C-2 3/4 x 4-48	1	12	16	5.1	1229	958	848	750	651
		1	18	22	5.9	1421	1108	980	867	753
		2	18	22	7.3	1754	1368	1211	1070	930
		1	24	28	6.6	1594	1243	1100	972	845
		2	24	28	9.4	2250	1755	1552	1372	1192
		3	24	28	11.1	2664	2078	1838	1625	1412
1 1/4" Dia. copper	1 1/4C-3 1/4 x 3 1/4-32	1	12	16	3.8	916	714	632	559	485
		1	18	22	4.0	950	741	656	580	504
		2	18	22	6.0	1437	1121	991	876	761
		1	24	28	4.2	1020	795	703	622	540
		2	24	28	6.9	1664	1298	1148	1015	882
		3	24	28	8.0	1908	1488	1317	1164	1011
	1 1/4C-3 1/4 x 3 1/4-40	1	12	16	4.3	1037	809	715	632	550
		1	18	22	4.8	1140	890	787	696	604
		2	18	22	6.7	1602	1250	1105	977	849
		1	24	28	5.1	1227	957	847	748	650
		2	24	28	7.5	1800	1404	1242	1098	954
		3	24	28	8.7	2079	1622	1435	1268	1102
	1 1/4C-3 1/4 x 3 1/4-48	1	12	16	4.8	1152	899	795	703	611
		1	18	22	5.6	1332	1039	919	813	706
		2	18	22	6.5	1550	1209	1070	946	822
		1	24	28	6.2	1494	1165	1031	911	792
		2	24	28	8.3	1988	1551	1372	1213	1054
		3	24	28	9.5	2284	1781	1576	1393	1210

*EDR - Equivalent Direct Radiation area (for steam heat) per active (finned) lineal foot of tube.

Important rating information Performance ratings based on:

- Installation at height shown. (Lower heights are not recommended; for greater heights refer to EZselect selection software).
- Entering air temperature of 65°F. (For other temperatures, refer to EZselect selection software).

- Steam at nominal 1 (actual 0.9) psig and 215°F. (For other conditions, refer to EZselect selection software).
- Water average temperature (°F) shown and velocity of 3 fps or more. (For lower velocities, refer to EZselect selection software).

Revised February 2016. Zehnder periodically makes changes to the design and/or specifications of its products. As a result, the design and specifications of each product at the time of order may be different than as described herein. Please contact Zehnder's Sales Support staff at 844-934-6337 for specific information on current design and specifications. Designs, specifications and other information contained herein are not express warranties, which are only as expressly set forth by Zehnder in its terms and conditions of sale. The latest version of this document is available at www.zehnder-ritting.com.

Enclosure Submittal Data

English, IP Units

General data

Performance ratings: model S-TP5/PR5; perforated enclosure

In BTU/hr per active (finned) lineal foot of tube at entering air temperature of 65°F

Element	Rows of element (on 6-inch centers)	Enclosure height (in inches)	Recommended minimum installed height (in inches)	EDR* (ft ² /ft)	Steam heat	Hot water heat				
					215°F factor of 1.00	190°F factor of 0.78	180°F factor of 0.69	170°F factor of 0.61	160°F factor of 0.53	
Copper element										
1 1/4" Dia. copper	1 1/4C-4 1/4 x 4 1/4-32	1	12	16	5.3	1270	990	880	780	670
		1	18	22	5.5	1330	1040	920	810	710
		2	18	22	8.2	1960	1530	1350	1200	1040
		1	24	28	5.9	1420	1110	980	870	750
		2	24	28	9.5	2220	1730	1530	1350	1180
		3	24	28	10.6	2540	1980	1750	1550	1350
	1 1/4C-4 1/4 x 4 1/4-40	1	12	16	6	1450	1130	1000	890	770
		1	18	22	6.6	1590	1240	1100	970	840
		2	18	22	8.9	2130	1660	1470	1300	1130
		1	24	28	7.1	1710	1330	1180	1040	910
		2	24	28	10	2390	1860	1650	1460	1270
		3	24	28	11.4	2740	2140	1890	1670	1450
	1 1/4C-4 1/4 x 4 1/4-48	1	12	16	6.4	1530	1190	1060	950	810
		1	18	22	7.4	1770	1380	1220	1090	940
		2	18	22	8.5	2050	1600	1420	1260	1090
		1	24	28	8.3	1980	1540	1370	1220	1050
		2	24	28	10.9	2620	2040	1800	1600	1390
		3	24	28	12.2	2930	2280	2020	1790	1550

*EDR - Equivalent Direct Radiation area (for steam heat) per active (finned) lineal foot of tube.

Important rating information Performance ratings based on:

- Installation at height shown. (Lower heights are not recommended; for greater heights refer to EZselect selection software).
- Entering air temperature of 65°F. (For other temperatures, refer to EZselect selection software).

- Steam at nominal 1 (actual 0.9) psig and 215°F. (For other conditions, refer to EZselect selection software).
- Water average temperature (°F) shown and velocity of 3 fps or more. (For lower velocities, refer to EZselect selection software).

Enclosure Submittal Data

English, IP Units

General data

Performance ratings: model S-FP5/S-RP5; perforated enclosure

In BTU/hr per active (finned) lineal foot of tube at entering air temperature of 65°F

Element	Rows of element (on 6-inch centers)	Enclosure height (in inches)	Recommended minimum installed height (in inches)	EDR* (ft ² /ft)	Steam heat	Hot water heat					
					215°F factor of 1.00	190°F factor of 0.78	180°F factor of 0.69	170°F factor of 0.61	160°F factor of 0.53		
Steel element											
1" Dia. steel	1S-3¼ X 3¼-32	1	12	16	3.6	867	676	598	529	460	
		1	18	22	3.8	905	706	624	552	480	
		2	18	22	5.5	1314	1025	907	801	696	
		1	24	28	3.8	924	720	637	563	490	
		2	24	28	5.8	1389	1083	958	847	736	
		3	24	28	6.5	1563	1219	1079	954	829	
	1S-3¼ X 3¼-40	1	12	16	3.9	946	738	652	577	501	
		1	18	22	4.2	1020	795	704	622	540	
		2	18	22	6.3	1504	1173	1038	917	797	
		1	24	28	4.4	1057	824	729	645	560	
		2	24	28	6.5	1562	1218	1078	953	828	
	1S-3¼ X 3¼-48	1	12	16	4.4	1067	832	736	651	565	
		1	18	22	4.9	1177	918	812	718	624	
		2	18	22	7.1	1707	1331	1177	1041	904	
		1	24	28	5.1	1214	947	838	741	643	
		2	24	28	7.4	1766	1378	1219	1077	936	
	1" Dia. steel	1S-4¼ X 4¼-32	1	12	16	4.6	1115	870	769	680	591
			1	18	22	4.8	1164	908	803	710	617
2			18	22	7.1	1697	1324	1171	1035	899	
1			24	28	4.9	1188	926	820	725	630	
2			24	28	7.5	1794	1399	1238	1094	951	
3			24	28	8.6	2060	1607	1422	1257	1092	
1S-4¼ X 4¼-40		1	12	16	5.2	1236	964	853	754	655	
		1	18	22	5.6	1333	1040	920	813	707	
		2	18	22	7.9	1891	1475	1305	1153	1002	
		1	24	28	5.8	1382	1078	953	843	732	
		2	24	28	8.2	1963	1531	1355	1198	1041	
1S-4¼ X 4¼-48		1	12	16	5.9	1406	1097	970	858	745	
		1	18	22	6.5	1551	1210	1070	946	822	
		2	18	22	8.7	2085	1626	1438	1272	1105	
		1	24	28	6.7	1600	1248	1104	976	848	
		2	24	28	9.0	2157	1683	1489	1316	1143	
		3	24	28	10.4	2497	1947	1723	1523	1323	

*EDR - Equivalent Direct Radiation area (for steam heat) per active (finned) lineal foot of tube.

Important rating information Performance ratings based on:

- Installation at height shown. (Lower heights are not recommended; for greater heights refer to EZselect selection software).
- Entering air temperature of 65°F. (For other temperatures, refer to EZselect selection software).

- Steam at nominal 1 (actual 0.9) psig and 215°F. (For other conditions, refer to EZselect selection software).
- Water average temperature (°F) shown and velocity of 3 fps or more. (For lower velocities, refer to EZselect selection software).

Revised February 2016. Zehnder periodically makes changes to the design and/or specifications of its products. As a result, the design and specifications of each product at the time of order may be different than as described herein. Please contact Zehnder's Sales Support staff at 844-934-6337 for specific information on current design and specifications. Designs, specifications and other information contained herein are not express warranties, which are only as expressly set forth by Zehnder in its terms and conditions of sale. The latest version of this document is available at www.zehnder-ritting.com.

Enclosure Submittal Data

English, IP Units

General data

Performance ratings: model S-FP5/S-RP5; perforated enclosure

In BTU/hr per active (finned) lineal foot of tube at entering air temperature of 65°F

Element	Rows of element (on 6-inch centers)	Enclosure height (in inches)	Recommended minimum installed height (in inches)	EDR* (ft ² /ft)	Steam heat	Hot water heat				
					215°F factor of 1.00	190°F factor of 0.78	180°F factor of 0.69	170°F factor of 0.61	160°F factor of 0.53	
Steel element										
1 1/4" Dia. steel	1 1/4S-3 1/4 X 3 1/4-32	1	12	16	3.5	850	663	587	519	451
		1	18	22	3.7	887	692	612	541	470
		2	18	22	5.5	1327	1035	916	810	703
		1	24	28	3.8	906	706	625	552	480
		2	24	28	5.8	1403	1094	968	856	744
		3	24	28	6.7	1612	1257	1112	983	854
	1 1/4S-3 1/4 X 3 1/4-40	1	12	16	3.8	918	716	633	560	487
		1	18	22	4.1	990	772	683	604	525
		2	18	22	6.1	1460	1139	1008	891	774
		1	24	28	4.3	1026	800	708	626	544
		2	24	28	6.3	1516	1183	1046	925	804
		3	24	28	7.4	1786	1393	1232	1089	946
	1 1/4S-3 1/4 X 3 1/4-48	1	12	16	4.2	1016	793	701	620	539
		1	18	22	4.7	1121	875	774	684	594
		2	18	22	6.7	1610	1256	1111	982	853
		1	24	28	4.8	1156	902	798	705	613
		2	24	28	6.9	1666	1300	1150	1016	883
		3	24	28	8.3	2002	1562	1382	1221	1061
1 1/4" Dia. steel	1 1/4S-4 1/4 X 4 1/4-32	1	12	16	4.6	1110	860	760	670	580
		1	18	22	4.8	1140	890	790	700	600
		2	18	22	7	1690	1320	1170	1030	900
		1	24	28	4.9	1170	910	810	710	620
		2	24	28	7.4	1770	1380	1220	1080	940
		3	24	28	8.5	2030	1580	1400	1240	1080
	1 1/4S-4 1/4 X 4 1/4-40	1	12	16	5.1	1230	960	850	750	650
		1	18	22	5.5	1330	1040	920	810	700
		2	18	22	7.8	1860	1450	1280	1130	990
		1	24	28	5.7	1360	1060	940	830	720
		2	24	28	8.1	1940	1510	1340	1180	1030
		3	24	28	9.3	2220	1730	1530	1350	1180
	1 1/4S-4 1/4 X 4 1/4-48	1	12	16	5.8	1380	1080	950	840	730
		1	18	22	6.4	1540	1200	1060	940	820
		2	18	22	8.6	2060	1610	1420	1260	1090
		1	24	28	6.6	1580	1230	1090	960	840
		2	24	28	8.9	2130	1660	1470	1300	1130
		3	24	28	10.3	2460	1920	1700	1500	1300

*EDR - Equivalent Direct Radiation area (for steam heat) per active (finned) lineal foot of tube.

Important rating information Performance ratings based on:

- Installation at height shown. (Lower heights are not recommended; for greater heights refer to EZselect selection software).
- Entering air temperature of 65°F. (For other temperatures, refer to EZselect selection software).

- Steam at nominal 1 (actual 0.9) psig and 215°F. (For other conditions, refer to EZselect selection software).
- Water average temperature (°F) shown and velocity of 3 fps or more. (For lower velocities, refer to EZselect selection software).

Revised February 2016. Zehnder periodically makes changes to the design and/or specifications of its products. As a result, the design and specifications of each product at the time of order may be different than as described herein. Please contact Zehnder's Sales Support staff at 844-934-6337 for specific information on current design and specifications. Designs, specifications and other information contained herein are not express warranties, which are only as expressly set forth by Zehnder in its terms and conditions of sale. The latest version of this document is available at www.zehnder-ritting.com.

Enclosure Submittal Data

English, IP Units

General data

Performance ratings: model S-FP5/S-RP5; perforated enclosure

In BTU/hr per active (finned) lineal foot of tube at entering air temperature of 65°F

Element	Rows of element (on 6-inch centers)	Enclosure height (in inches)	Recommended minimum installed height (in inches)	EDR* (ft ² /ft)	Steam heat	Hot water heat				
					215°F factor of 1.00	190°F factor of 0.78	180°F factor of 0.69	170°F factor of 0.61	160°F factor of 0.53	
Steel element										
2" Dia. steel	2S-4¼ X 4¼-32	1	12	16	4.4	1060	827	731	647	562
		1	18	22	4.6	1106	863	763	675	586
		2	18	22	6.8	1630	1271	1124	994	864
		1	24	28	4.7	1129	881	779	689	598
		2	24	28	7.2	1723	1344	1189	1051	913
		3	24	28	8.2	1979	1543	1365	1207	1049
	2S-4¼ X 4¼-40	1	12	16	4.9	1187	926	819	724	629
		1	18	22	5.3	1280	999	883	781	679
		2	18	22	7.5	1797	1402	1240	1096	952
		1	24	28	5.5	1327	1035	916	809	703
		2	24	28	7.8	1866	1456	1288	1138	989
		3	24	28	8.8	2120	1654	1463	1293	1124
	2S-4¼ X 4¼-48	1	12	16	5.6	1350	1053	932	824	716
		1	18	22	6.2	1490	1162	1028	909	790
		2	18	22	8.2	1961	1529	1353	1196	1039
		1	24	28	6.4	1536	1198	1060	937	814
		2	24	28	8.5	2029	1583	1400	1238	1075
		3	24	28	9.7	2324	1812	1603	1417	1232

*EDR - Equivalent Direct Radiation area (for steam heat) per active (finned) lineal foot of tube.

Important rating information Performance ratings based on:

- Installation at height shown. (Lower heights are not recommended; for greater heights refer to EZselect selection software).
- Entering air temperature of 65°F. (For other temperatures, refer to EZselect selection software).

- Steam at nominal 1 (actual 0.9) psig and 215°F. (For other conditions, refer to EZselect selection software).
- Water average temperature (°F) shown and velocity of 3 fps or more. (For lower velocities, refer to EZselect selection software).

Enclosure Submittal Data

English, IP Units

General data

Performance ratings: model S-FP5/S-RP5; perforated enclosure

In BTU/hr per active (finned) lineal foot of tube at entering air temperature of 65°F

Element	Rows of element (on 6-inch centers)	Enclosure height (in inches)	Recommended minimum installed height (in inches)	EDR* (ft ² /ft)	Steam heat	Hot water heat				
					215°F factor of 1.00	190°F factor of 0.78	180°F factor of 0.69	170°F factor of 0.61	160°F factor of 0.53	
Copper element										
3/4" Dia. copper	3/4C-2 3/4 x 4-32	1	12	16	4.3	1037	809	715	632	550
		1	18	22	4.6	1114	869	768	679	590
		2	18	22	7.3	1754	1368	1211	1070	930
		1	24	28	4.9	1171	914	808	714	621
		2	24	28	8.2	1961	1529	1353	1196	1039
		3	24	28	9.7	2323	1812	1603	1417	1231
	3/4C-2 3/4 x 4-40	1	12	16	5.2	1240	967	855	756	657
		1	18	22	5.7	1358	1059	937	828	720
		2	18	22	8.2	1965	1533	1356	1199	1042
		1	24	28	6.0	1437	1121	991	876	761
		2	24	28	9.2	2200	1716	1518	1342	1166
		3	24	28	10.9	2605	2032	1798	1589	1381
	3/4C-2 3/4 x 4-48	1	12	16	5.4	1299	1013	896	792	688
		1	18	22	6.2	1496	1167	1032	912	793
		2	18	22	8.1	1943	1516	1341	1185	1030
		1	24	28	7.1	1692	1320	1168	1032	897
		2	24	28	9.5	2274	1774	1569	1387	1205
		3	24	28	11.4	2747	2143	1895	1676	1456
3/4" Dia. copper	3/4C-3 1/4 x 3 1/4-32	1	12	16	4.1	972	758	671	593	515
		1	18	22	4.4	1044	814	720	637	553
		2	18	22	6.7	1612	1257	1112	983	854
		1	24	28	4.6	1098	856	758	670	582
		2	24	28	7.5	1801	1405	1243	1099	955
		3	24	28	8.8	2112	1647	1457	1288	1119
	3/4C-3 1/4 x 3 1/4-40	1	12	16	4.7	1134	885	782	692	601
		1	18	22	5.2	1242	969	857	758	658
		2	18	22	7.4	1766	1378	1219	1078	936
		1	24	28	5.5	1314	1025	907	802	696
		2	24	28	8.2	1978	1543	1365	1206	1048
		3	24	28	9.7	2322	1811	1602	1417	1231
	3/4C-3 1/4 x 3 1/4-48	1	12	16	5.0	1188	927	820	725	630
		1	18	22	5.7	1368	1067	944	834	725
		2	18	22	7.1	1711	1334	1180	1044	907
		1	24	28	6.5	1548	1207	1068	944	820
		2	24	28	8.3	2002	1562	1382	1221	1061
		3	24	28	9.9	2379	1856	1641	1451	1261

*EDR - Equivalent Direct Radiation area (for steam heat) per active (finned) lineal foot of tube.

Important rating information Performance ratings based on:

- Installation at height shown. (Lower heights are not recommended; for greater heights refer to EZselect selection software).
- Entering air temperature of 65°F. (For other temperatures, refer to EZselect selection software).

- Steam at nominal 1 (actual 0.9) psig and 215°F. (For other conditions, refer to EZselect selection software).
- Water average temperature (°F) shown and velocity of 3 fps or more. (For lower velocities, refer to EZselect selection software).

Revised February 2016. Zehnder periodically makes changes to the design and/or specifications of its products. As a result, the design and specifications of each product at the time of order may be different than as described herein. Please contact Zehnder's Sales Support staff at 844-934-6337 for specific information on current design and specifications. Designs, specifications and other information contained herein are not express warranties, which are only as expressly set forth by Zehnder in its terms and conditions of sale. The latest version of this document is available at www.zehnder-ritting.com.

Enclosure Submittal Data

English, IP Units

General data

Performance ratings: model S-FP5/S-RP5; perforated enclosure

In BTU/hr per active (finned) lineal foot of tube at entering air temperature of 65°F

Element	Rows of element (on 6-inch centers)	Enclosure height (in inches)	Recommended minimum installed height (in inches)	EDR* (ft ² /ft)	Steam heat	Hot water heat				
					215°F factor of 1.00	190°F factor of 0.78	180°F factor of 0.69	170°F factor of 0.61	160°F factor of 0.53	
Copper element										
¾" Dia. copper	¾C-4¼ x 4¼-32	1	12	16	5.4	1290	1010	890	790	680
		1	18	22	5.8	1390	1080	960	850	740
		2	18	22	8.5	2040	1590	1410	1240	1080
		1	24	28	6.1	1470	1150	1010	900	780
		2	24	28	9.5	2290	1790	1580	1400	1210
		3	24	28	11	2630	2050	1810	1600	1390
	¾C-4¼ x 4¼-40	1	12	16	6.3	1510	1180	1040	920	800
		1	18	22	6.9	1640	1280	1130	1000	870
		2	18	22	9.2	2200	1720	1520	1340	1170
		1	24	28	7.3	1760	1370	1210	1070	930
		2	24	28	10.3	2470	1930	1700	1510	1310
		3	24	28	11.8	2840	2220	1960	1730	1510
	¾C-4¼ x 4¼-48	1	12	16	6.6	1590	1240	1100	970	840
		1	18	22	7.6	1830	1430	1260	1120	970
		2	18	22	8.8	2120	1650	1460	1290	120
		1	24	28	8.6	2060	1610	1420	1260	1090
		2	24	28	10.3	2470	1930	1700	1510	1310
		3	24	28	11.8	2830	2210	1950	1730	1500
1" Dia. copper	1C-2¾ x 4-32	1	12	16	4.0	968	755	668	590	513
		1	18	22	4.3	1020	796	704	622	541
		2	18	22	6.1	1465	1143	1011	894	776
		1	24	28	4.4	1046	816	722	638	555
		2	24	28	7.0	1674	1306	1155	1021	887
		3	24	28	8.3	1998	1558	1379	1219	1059
	1C-2¾ x 4-40	1	12	16	5.1	1220	952	842	744	647
		1	18	22	5.5	1329	1037	917	811	704
		2	18	22	7.2	1716	1338	1184	1047	909
		1	24	28	6.0	1437	1121	992	877	762
		2	24	28	8.0	1927	1503	1330	1176	1021
		3	24	28	9.5	2271	1771	1567	1385	1204
	1C-2¾ x 4-48	1	12	16	5.2	1258	981	868	768	667
		1	18	22	6.0	1438	1122	992	877	762
		2	18	22	7.2	1736	1354	1198	1059	920
		1	24	28	6.6	1592	1242	1099	971	844
		2	24	28	8.5	2034	1587	1403	1241	1078
		3	24	28	10.1	2422	1889	1671	1477	1284

*EDR - Equivalent Direct Radiation area (for steam heat) per active (finned) lineal foot of tube.

Important rating information Performance ratings based on:

- Installation at height shown. (Lower heights are not recommended; for greater heights refer to EZselect selection software).
- Entering air temperature of 65°F. (For other temperatures, refer to EZselect selection software).

- Steam at nominal 1 (actual 0.9) psig and 215°F. (For other conditions, refer to EZselect selection software).
- Water average temperature (°F) shown and velocity of 3 fps or more. (For lower velocities, refer to EZselect selection software).

Revised February 2016. Zehnder periodically makes changes to the design and/or specifications of its products. As a result, the design and specifications of each product at the time of order may be different than as described herein. Please contact Zehnder's Sales Support staff at 844-934-6337 for specific information on current design and specifications. Designs, specifications and other information contained herein are not express warranties, which are only as expressly set forth by Zehnder in its terms and conditions of sale. The latest version of this document is available at www.zehnder-ritting.com.

Enclosure Submittal Data

English, IP Units

General data

Performance ratings: model S-FP5/S-RP5; perforated enclosure

In BTU/hr per active (finned) lineal foot of tube at entering air temperature of 65°F

Element	Rows of element (on 6-inch centers)	Enclosure height (in inches)	Recommended minimum installed height (in inches)	EDR* (ft ² /ft)	Steam heat	Hot water heat				
					215°F factor of 1.00	190°F factor of 0.78	180°F factor of 0.69	170°F factor of 0.61	160°F factor of 0.53	
Copper element										
1" Dia. copper	1C-3¼ x 3¼-32	1	12	16	3.7	880	690	610	540	470
		1	18	22	3.9	930	730	640	570	490
		2	18	22	5.6	1360	1060	940	830	720
		1	24	28	4	990	770	680	600	520
		2	24	28	6.4	1540	1200	1060	940	820
		3	24	28	7.5	1790	1400	1240	1090	950
	1C-3¼ x 3¼-40	1	12	16	4.5	1070	830	740	650	570
		1	18	22	4.9	1170	910	810	710	620
		2	18	22	6.5	1560	1220	1080	950	830
		1	24	28	5.3	1280	1000	880	780	680
		2	24	28	7.3	1740	1360	1200	1060	920
		3	24	28	8.3	2000	1560	1380	1220	1060
	1C-3¼ x 3¼-48	1	12	16	4.9	1170	910	810	710	620
		1	18	22	5.6	1350	1050	930	820	720
		2	18	22	6.4	1540	1200	1060	940	820
		1	24	28	6.2	1490	1160	1030	910	790
		2	24	28	7.5	1810	1410	1250	1100	960
		3	24	28	8.7	2080	1620	1430	1270	1100
1" Dia. copper	1C-4¼ x 4¼-32	1	12	16	5.3	1270	990	880	780	670
		1	18	22	5.7	1360	1060	940	830	720
		2	18	22	8.3	2000	1560	1380	1220	1060
		1	24	28	6	1440	1120	990	880	760
		2	24	28	9.4	2250	1760	1550	1370	1190
		3	24	28	10.8	2580	2010	1780	1570	1370
	1C-4¼ x 4¼-40	1	12	16	6.2	1480	1150	1020	900	780
		1	18	22	6.7	1610	1260	1110	980	850
		2	18	22	9	2160	1690	1490	1320	1150
		1	24	28	7.2	1730	1350	1190	1060	920
		2	24	28	10.1	2420	1890	1670	1480	1280
		3	24	28	11.6	2780	2170	1920	1700	1470
	1C-4¼ x 4¼-48	1	12	16	6.5	1560	1220	1080	950	830
		1	18	22	7.5	1790	1400	1240	1090	950
		2	18	22	8.7	2080	1620	1440	1270	110
		1	24	28	8.4	2020	1580	1390	1230	1070
		2	24	28	10.8	2600	2020	1790	1580	1370
		3	24	28	12.4	2980	2320	2050	1820	1580

*EDR - Equivalent Direct Radiation area (for steam heat) per active (finned) lineal foot of tube.

Important rating information Performance ratings based on:

- Installation at height shown. (Lower heights are not recommended; for greater heights refer to EZselect selection software).
- Entering air temperature of 65°F. (For other temperatures, refer to EZselect selection software).

- Steam at nominal 1 (actual 0.9) psig and 215°F. (For other conditions, refer to EZselect selection software).
- Water average temperature (°F) shown and velocity of 3 fps or more. (For lower velocities, refer to EZselect selection software).

Revised February 2016. Zehnder periodically makes changes to the design and/or specifications of its products. As a result, the design and specifications of each product at the time of order may be different than as described herein. Please contact Zehnder's Sales Support staff at 844-934-6337 for specific information on current design and specifications. Designs, specifications and other information contained herein are not express warranties, which are only as expressly set forth by Zehnder in its terms and conditions of sale. The latest version of this document is available at www.zehnder-ritting.com.

Enclosure Submittal Data

English, IP Units

General data

Performance ratings: model S-FP5/S-RP5; perforated enclosure

In BTU/hr per active (finned) lineal foot of tube at entering air temperature of 65°F

Element	Rows of element (on 6-inch centers)	Enclosure height (in inches)	Recommended minimum installed height (in inches)	EDR* (ft ² /ft)	Steam heat	Hot water heat				
					215°F factor of 1.00	190°F factor of 0.78	180°F factor of 0.69	170°F factor of 0.61	160°F factor of 0.53	
Copper element										
1 1/4" Dia. copper	1 1/4C-2 3/4 x 4-32	1	12	16	4.1	992	774	685	605	526
		1	18	22	4.3	1030	803	710	628	546
		2	18	22	6.6	1574	1228	1086	960	834
		1	24	28	4.6	1104	861	762	674	585
		2	24	28	7.6	1824	1423	1259	1113	967
		3	24	28	8.8	2112	1647	1457	1288	1119
	1 1/4C-2 3/4 x 4-40	1	12	16	4.9	1181	921	815	720	626
		1	18	22	5.4	1299	1013	896	792	688
		2	18	22	7.4	1773	1383	1223	1081	940
		1	24	28	5.8	1397	1090	964	852	741
		2	24	28	8.3	1992	1554	1374	1215	1056
		3	24	28	9.9	2380	1857	1642	1452	1262
	1 1/4C-2 3/4 x 4-48	1	12	16	5.1	1229	958	848	750	651
		1	18	22	5.9	1421	1108	980	867	753
		2	18	22	7.3	1754	1368	1211	1070	930
		1	24	28	6.6	1594	1243	1100	972	845
		2	24	28	9.4	2250	1755	1552	1372	1192
		3	24	28	11.1	2664	2078	1838	1625	1412
1 1/4" Dia. copper	1 1/4C-3 1/4 x 3 1/4-32	1	12	16	3.8	916	714	632	559	485
		1	18	22	4.0	950	741	656	580	504
		2	18	22	6.0	1437	1121	991	876	761
		1	24	28	4.2	1020	795	703	622	540
		2	24	28	6.9	1664	1298	1148	1015	882
		3	24	28	8.0	1908	1488	1317	1164	1011
	1 1/4C-3 1/4 x 3 1/4-40	1	12	16	4.3	1037	809	715	632	550
		1	18	22	4.8	1140	890	787	696	604
		2	18	22	6.7	1602	1250	1105	977	849
		1	24	28	5.1	1227	957	847	748	650
		2	24	28	7.5	1800	1404	1242	1098	954
		3	24	28	8.7	2079	1622	1435	1268	1102
	1 1/4C-3 1/4 x 3 1/4-48	1	12	16	4.8	1152	899	795	703	611
		1	18	22	5.6	1332	1039	919	813	706
		2	18	22	6.5	1550	1209	1070	946	822
		1	24	28	6.2	1494	1165	1031	911	792
		2	24	28	8.3	1988	1551	1372	1213	1054
		3	24	28	9.5	2284	1781	1576	1393	1210

*EDR - Equivalent Direct Radiation area (for steam heat) per active (finned) lineal foot of tube.

Important rating information Performance ratings based on:

- Installation at height shown. (Lower heights are not recommended; for greater heights refer to EZselect selection software).
- Entering air temperature of 65°F. (For other temperatures, refer to EZselect selection software).

- Steam at nominal 1 (actual 0.9) psig and 215°F. (For other conditions, refer to EZselect selection software).
- Water average temperature (°F) shown and velocity of 3 fps or more. (For lower velocities, refer to EZselect selection software).

Revised February 2016. Zehnder periodically makes changes to the design and/or specifications of its products. As a result, the design and specifications of each product at the time of order may be different than as described herein. Please contact Zehnder's Sales Support staff at 844-934-6337 for specific information on current design and specifications. Designs, specifications and other information contained herein are not express warranties, which are only as expressly set forth by Zehnder in its terms and conditions of sale. The latest version of this document is available at www.zehnder-ritting.com.

Enclosure Submittal Data

English, IP Units

General data

Performance ratings: model S-FP5/S-RP5; perforated enclosure

In BTU/hr per active (finned) lineal foot of tube at entering air temperature of 65°F

Element	Rows of element (on 6-inch centers)	Enclosure height (in inches)	Recommended minimum installed height (in inches)	EDR* (ft ² /ft)	Steam heat	Hot water heat				
					215°F factor of 1.00	190°F factor of 0.78	180°F factor of 0.69	170°F factor of 0.61	160°F factor of 0.53	
Copper element										
1 1/4" Dia. copper	1 1/4C-4 1/4 x 4 1/4-32	1	12	16	5.3	1270	990	880	780	670
		1	18	22	5.5	1330	1040	920	810	710
		2	18	22	8.2	1960	1530	1350	1200	1040
		1	24	28	5.9	1420	1110	980	870	750
		2	24	28	9.5	2220	1730	1530	1350	1180
		3	24	28	10.6	2540	1980	1750	1550	1350
	1 1/4C-4 1/4 x 4 1/4-40	1	12	16	6	1450	1130	1000	890	770
		1	18	22	6.6	1590	1240	1100	970	840
		2	18	22	8.9	2130	1660	1470	1300	1130
		1	24	28	7.1	1710	1330	1180	1040	910
		2	24	28	10	2390	1860	1650	1460	1270
		3	24	28	11.4	2740	2140	1890	1670	1450
	1 1/4C-4 1/4 x 4 1/4-48	1	12	16	6.4	1530	1190	1060	950	810
		1	18	22	7.4	1770	1380	1220	1090	940
		2	18	22	8.5	2050	1600	1420	1260	1090
		1	24	28	8.3	1980	1540	1370	1220	1050
		2	24	28	10.9	2620	2040	1800	1600	1390
		3	24	28	12.2	2930	2280	2020	1790	1550

*EDR - Equivalent Direct Radiation area (for steam heat) per active (finned) lineal foot of tube.

Important rating information Performance ratings based on:

- Installation at height shown. (Lower heights are not recommended; for greater heights refer to EZselect selection software).
- Entering air temperature of 65°F. (For other temperatures, refer to EZselect selection software).

- Steam at nominal 1 (actual 0.9) psig and 215°F. (For other conditions, refer to EZselect selection software).
- Water average temperature (°F) shown and velocity of 3 fps or more. (For lower velocities, refer to EZselect selection software).

Enclosure Submittal Data

English, IP Units

Dimensional data

Perforated steel enclosures

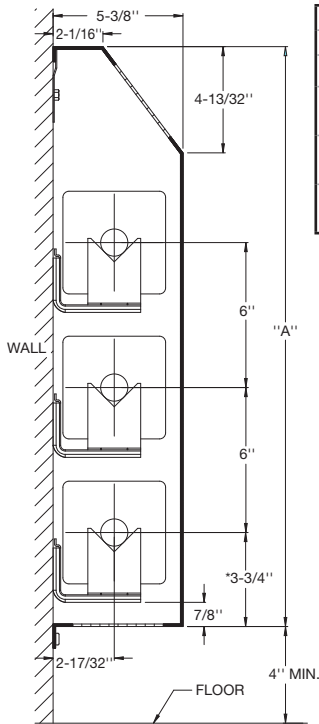

S-SP5			
Pipe size		Fin size	A
Steel	Copper		
N/A	3/4", 1", 1-1/4"	2-3/4" x 4"	12"
1", 1-1/4", 2	3/4", 1", 1-1/4"	3-1/4" x 3-1/4"	18"
1", 1-1/4", 2	3/4", 1", 1-1/4"	4-1/4" x 4-1/4"	24"

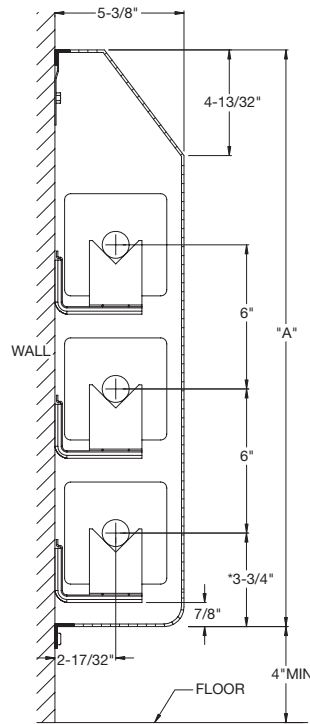

PS5			
Pipe size		Fin size	A
Steel	Copper		
N/A	3/4", 1", 1-1/4"	2-3/4" x 4"	12"
1", 1-1/4", 2	3/4", 1", 1-1/4"	3-1/4" x 3-1/4"	18"
1", 1-1/4", 2	3/4", 1", 1-1/4"	4-1/4" x 4-1/4"	24"

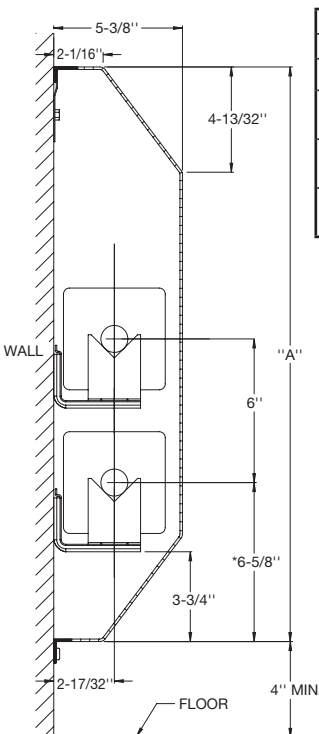

S-DSP5, PDS5 (shown)			
Pipe size		Fin size	A
Steel	Copper		
N/A	3/4", 1", 1-1/4"	2-3/4" x 4"	12"
1", 1-1/4", 2	3/4", 1", 1-1/4"	3-1/4" x 3-1/4"	18"
1", 1-1/4", 2	3/4", 1", 1-1/4"	4-1/4" x 4-1/4"	24"

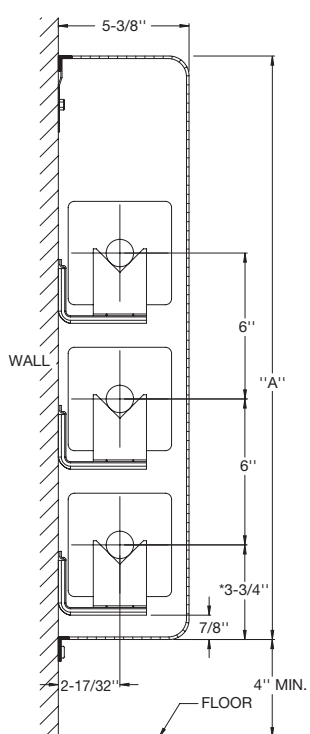

S-TP5, S-FP5, S-RP5, PR5 (shown)			
Pipe size		Fin size	A
Steel	Copper		
N/A	3/4", 1", 1-1/4"	2-3/4" x 4"	12"
1", 1-1/4", 2	3/4", 1", 1-1/4"	3-1/4" x 3-1/4"	18"
1", 1-1/4", 2	3/4", 1", 1-1/4"	4-1/4" x 4-1/4"	24"

Notes:

■ *Centerlines are based on 1" copper tube.

■ Damper option and number of rows available are dependant on enclosure size and piping configurations. (see page 55)

Revised February 2016. Zehnder periodically makes changes to the design and/or specifications of its products. As a result, the design and specifications of each product at the time of order may be different than as described herein. Please contact Zehnder's Sales Support staff at 844-934-6337 for specific information on current design and specifications. Designs, specifications and other information contained herein are not express warranties, which are only as expressly set forth by Zehnder in its terms and conditions of sale. The latest version of this document is available at www.zehnder-ritting.com.

Enclosure Submittal Data

English, IP Units

Dimensional data

Louvered steel enclosures

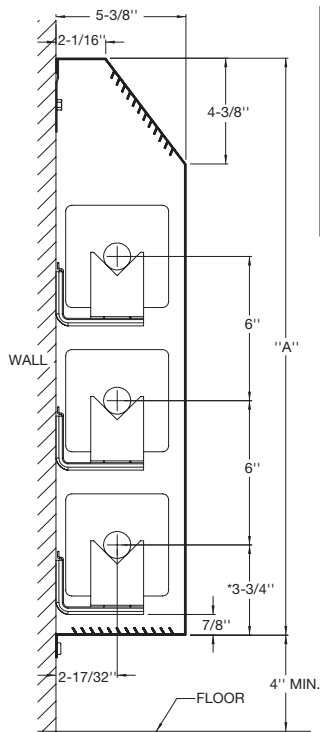

S-SL			
Pipe size		Fin size	A
Steel	Copper		
N/A	3/4", 1", 1-1/4"	2-3/4" x 4"	12"
1", 1-1/4"	3/4", 1", 1-1/4"	3-1/4" x 3-1/4"	18"
1", 1-1/4", 2"	3/4", 1", 1-1/4"	4-1/4" x 4-1/4"	24"

Notes:

- *Centerlines are based on 1" copper tube.
- Damper option and number of rows available are dependant on enclosure size and piping configurations. (see page 55)

Revised February 2016. Zehnder periodically makes changes to the design and/or specifications of its products. As a result, the design and specifications of each product at the time of order may be different than as described herein. Please contact Zehnder's Sales Support staff at 844-934-6337 for specific information on current design and specifications. Designs, specifications and other information contained herein are not express warranties, which are only as expressly set forth by Zehnder in its terms and conditions of sale. The latest version of this document is available at www.zehnder-ritting.com.

Enclosure Submittal Data

English, IP Units

Accessories

S-SP5

- Standard enclosures are available in 1' to 8' lengths in 6" increments

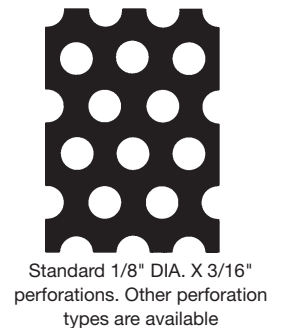
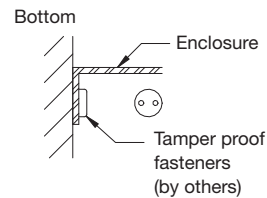
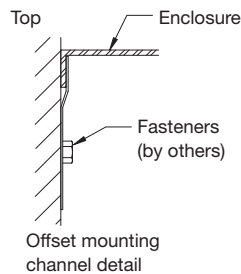
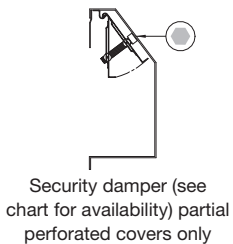
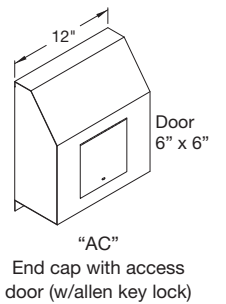
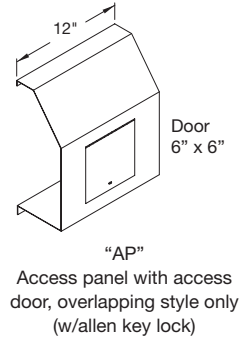
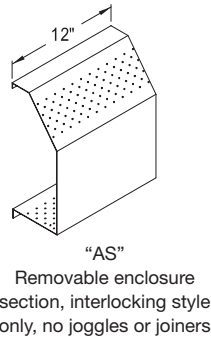
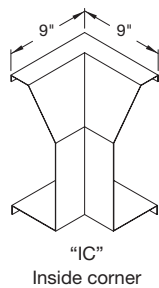
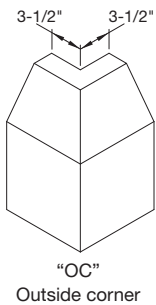
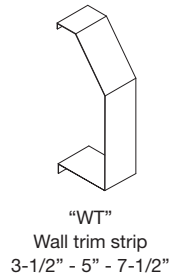
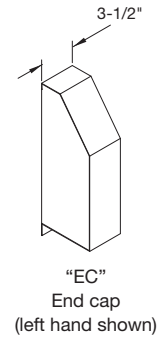
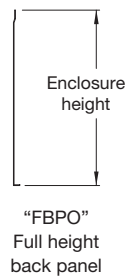
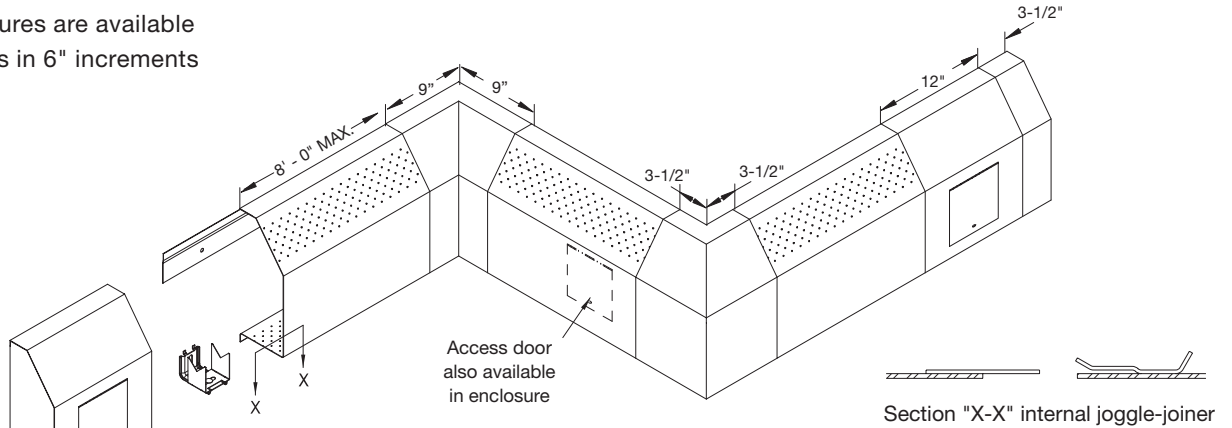

- Notes:**
- All accessories are overlap type, butt type optional (except as noted)

Revised February 2016. Zehnder periodically makes changes to the design and/or specifications of its products. As a result, the design and specifications of each product at the time of order may be different than as described herein. Please contact Zehnder's Sales Support staff at 844-934-6337 for specific information on current design and specifications. Designs, specifications and other information contained herein are not express warranties, which are only as expressly set forth by Zehnder in its terms and conditions of sale. The latest version of this document is available at www.zehnder-ritting.com.

Enclosure Submittal Data

English, IP Units

Accessories

PS5

- Standard enclosures are available in 1' to 8' lengths in 6" increments

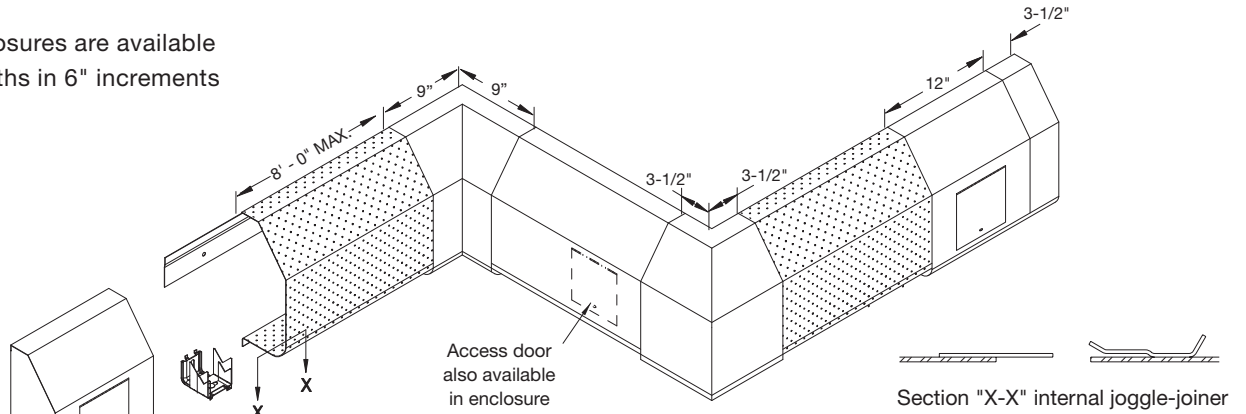

"OC"
Offset channel



"SLSRB"
Slip-in second row bracket



"WPH"
Wall pipe hanger

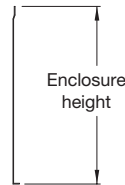

"FBPO"
Full height back panel

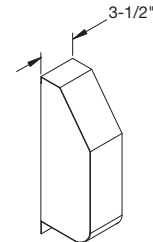

"EC"
End cap
(left hand shown)

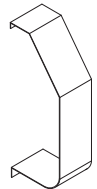

"WT"
Wall trim strip
3-1/2" - 5" - 7-1/2"

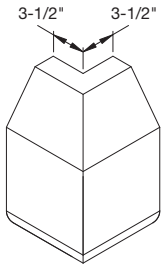

"OC"
Outside corner

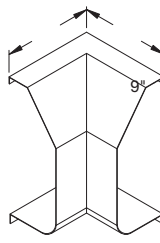

"IC"
Inside corner

9"

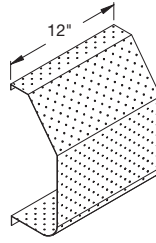

"AS"
Removable enclosure section, interlocking style only, no joggles or joiners

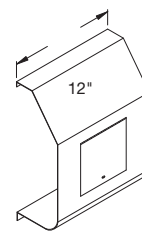

"AP"
Access panel with access door, overlapping style only (w/allen key lock)

Door
6" x 6"

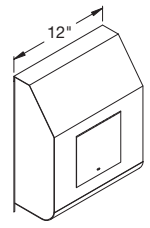

"AC"
End cap with access door (w/allen key lock)

Door
6" x 6"

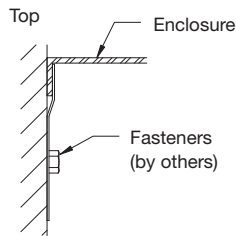

Offset mounting channel detail

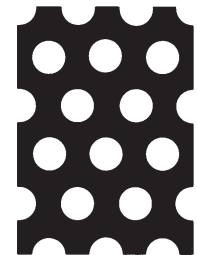
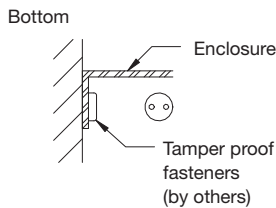

Standard 1/8" DIA. X 3/16" perforations
Other perforation types are available

Notes:

- All accessories are overlap type, butt type optional (except as noted)

Revised February 2016. Zehnder periodically makes changes to the design and/or specifications of its products. As a result, the design and specifications of each product at the time of order may be different than as described herein. Please contact Zehnder's Sales Support staff at 844-934-6337 for specific information on current design and specifications. Designs, specifications and other information contained herein are not express warranties, which are only as expressly set forth by Zehnder in its terms and conditions of sale. The latest version of this document is available at www.zehnder-ritting.com.

Enclosure Submittal Data

English, IP Units

Accessories

S-DSP5 (shown) / PDS5

- Standard enclosures are available in 1' to 8' lengths in 6" increments

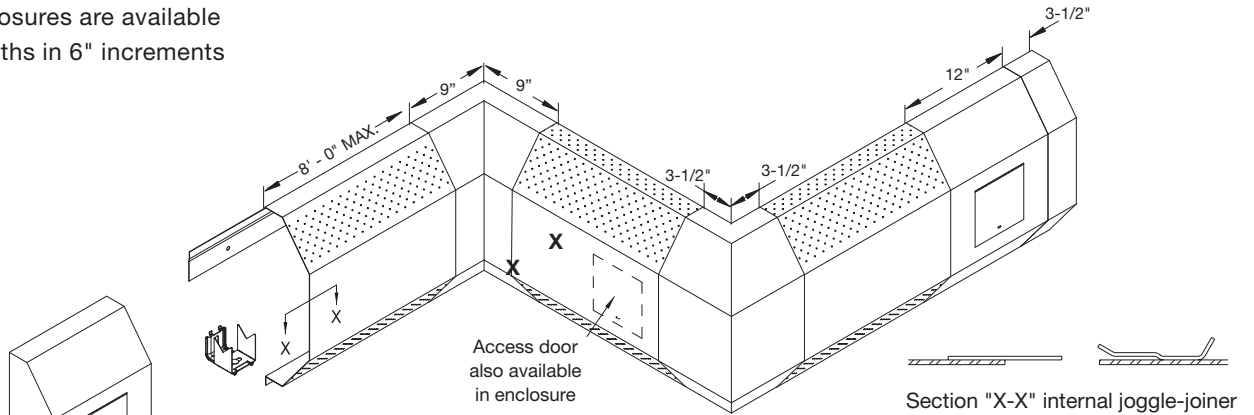

"OC"
Offset channel



"SLSRB"
Slip-in second row bracket



"WPH"
Wall pipe hanger

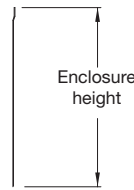

"FBPO"
Full height back panel

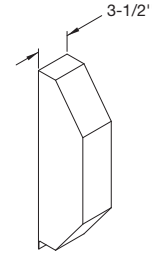

"EC"
End cap (left hand shown)

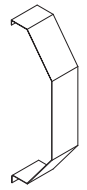

"WT"
Wall trim strip
3-1/2" - 5" - 7-1/2"

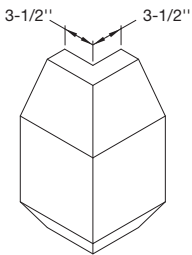

"OC"
Outside corner

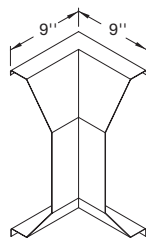

"IC"
Inside corner

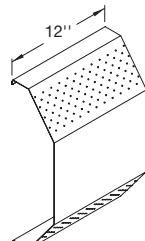

"AS"
Removable enclosure section, interlocking style only, no joggles or joiners

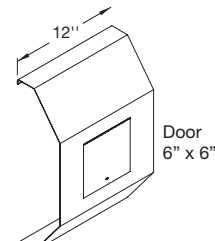

"AP"
Access panel with access door, overlapping style only (w/allen key lock)

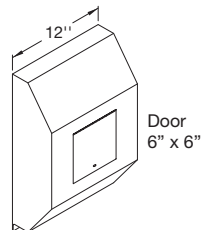

"AC"
End cap with access door (w/allen key lock)



Security damper (see chart for availability) partial perforated covers only

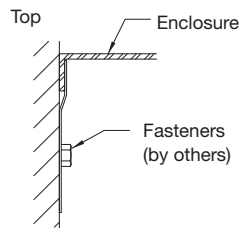

Offset mounting channel detail

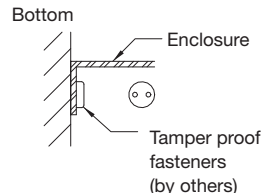

Tamper proof fasteners (by others)

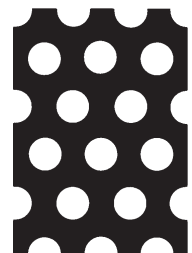

Standard 1/8" DIA. X 3/16" perforations. Other perforation types are available

Notes:

- All accessories are overlap type, butt type optional (except as noted)

Revised February 2016. Zehnder periodically makes changes to the design and/or specifications of its products. As a result, the design and specifications of each product at the time of order may be different than as described herein. Please contact Zehnder's Sales Support staff at 844-934-6337 for specific information on current design and specifications. Designs, specifications and other information contained herein are not express warranties, which are only as expressly set forth by Zehnder in its terms and conditions of sale. The latest version of this document is available at www.zehnder-ritting.com.

Enclosure Submittal Data

English, IP Units

Accessories

S-TP5 (shown) / S-FP5 / PR5

- Standard enclosures are available in 1' to 8' lengths in 6" increments

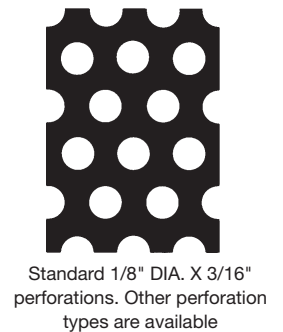
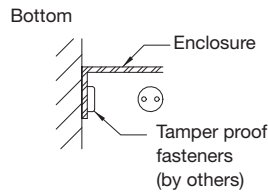
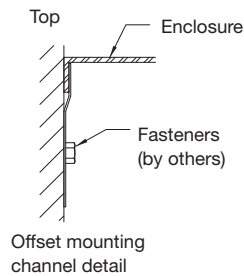
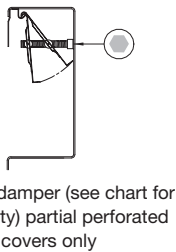
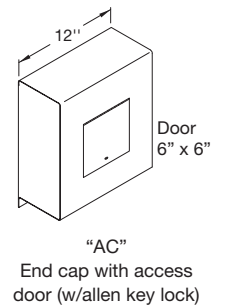
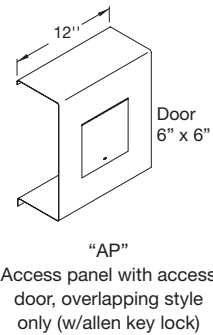
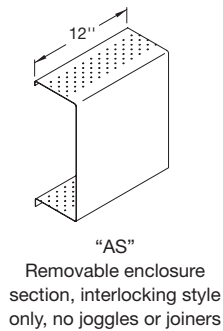
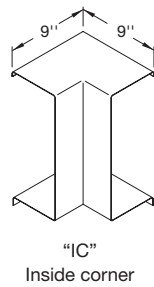
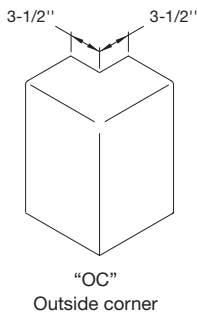
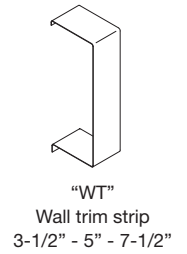
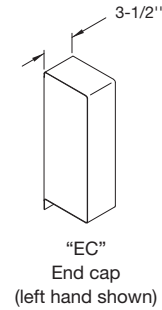
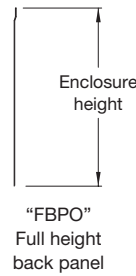
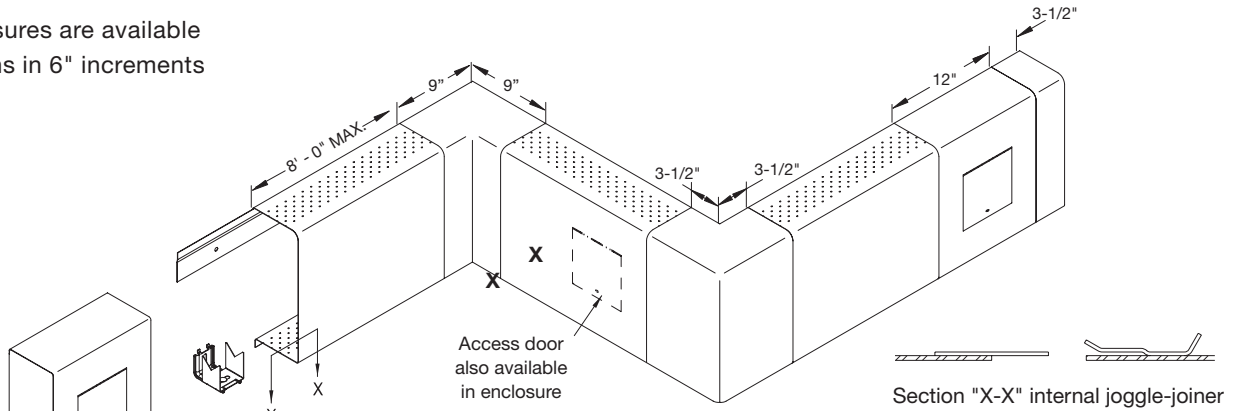

- Notes:**
- All accessories are overlap type, butt type optional (except as noted)

Revised February 2016. Zehnder periodically makes changes to the design and/or specifications of its products. As a result, the design and specifications of each product at the time of order may be different than as described herein. Please contact Zehnder's Sales Support staff at 844-934-6337 for specific information on current design and specifications. Designs, specifications and other information contained herein are not express warranties, which are only as expressly set forth by Zehnder in its terms and conditions of sale. The latest version of this document is available at www.zehnder-ritting.com.

Enclosure Submittal Data

English, IP Units

Accessories

S-SL

- Standard enclosures are available in 1' to 8' lengths in 6" increments

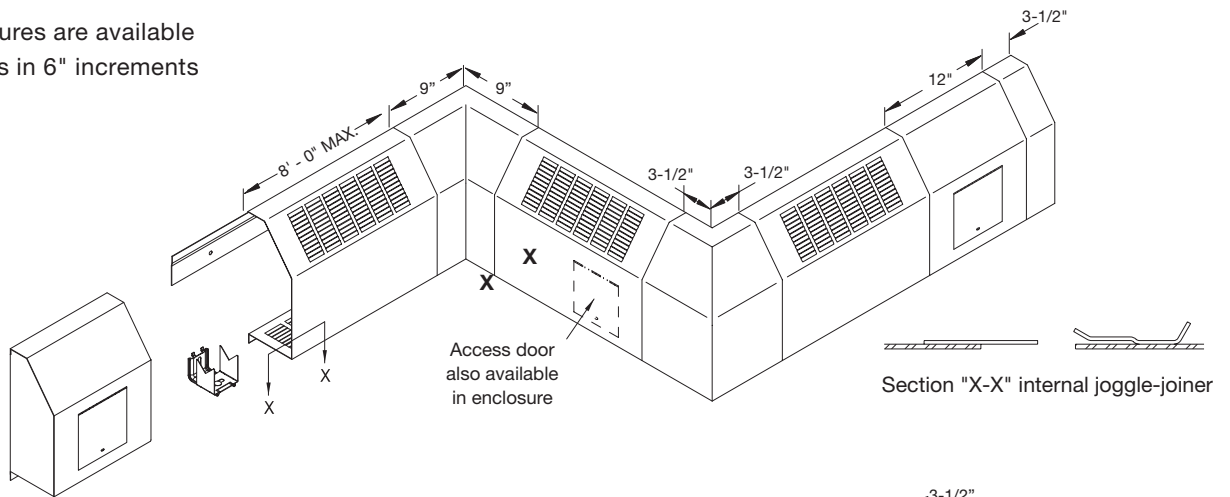

Section "X-X" internal joggle-joiner

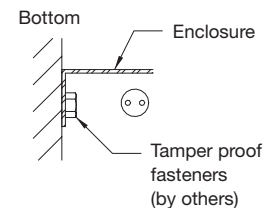
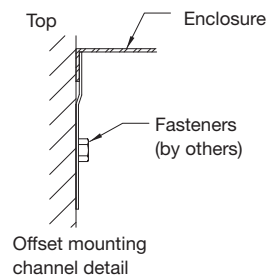
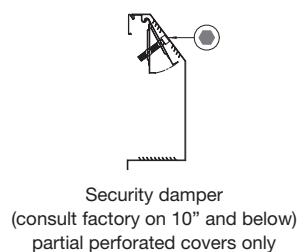
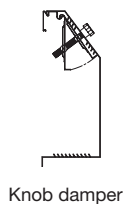
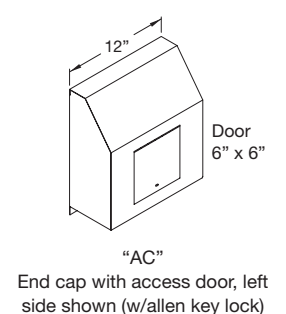
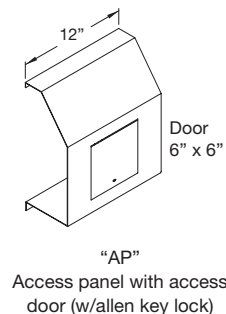
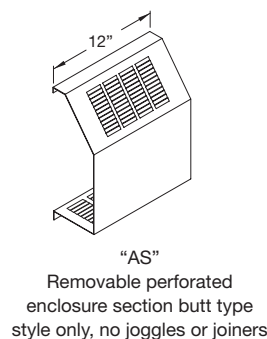
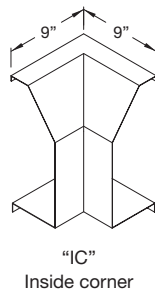
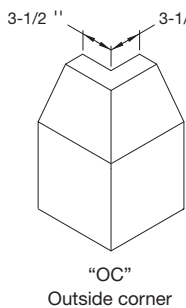
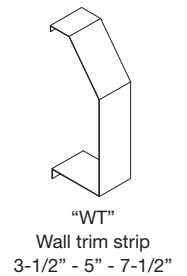
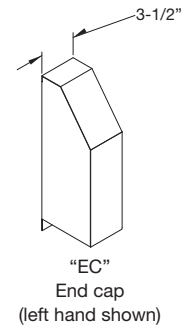
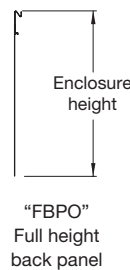

Notes:

- All accessories are overlap type, butt type optional (except as noted)

Revised February 2016. Zehnder periodically makes changes to the design and/or specifications of its products. As a result, the design and specifications of each product at the time of order may be different than as described herein. Please contact Zehnder's Sales Support staff at 844-934-6337 for specific information on current design and specifications. Designs, specifications and other information contained herein are not express warranties, which are only as expressly set forth by Zehnder in its terms and conditions of sale. The latest version of this document is available at www.zehnder-ritting.com.

Mechanical specifications

General

Furnish and install finned tube heating elements and enclosures as indicated on plans, with required mounting components and accessories. Material shall be manufactured in accordance with Zehnder Rittling's High Quality Standards and in conformance to ISO 9001:2008 standards established and maintained by Zehnder Rittling of Buffalo, New York.

Steel heating elements

Steel heating elements shall consist of 0.027" thick galvanized fins permanently bonded to high pressure A106 seamless schedule 40B steel tubing by mechanically expanding the steel tubing to the steel fins. Steel tube wall thickness; 1" dia. - 0.133", 1-1/4" dia. - 0.140", 2" dia - 0.154", prior to tube expansion.

Guaranteed working pressures:

1" IPS - 780 psig at temperature up to 650°F. 1-1/4" IPS - 660 psig at temperatures up to 650°F.

2" IPS - 405 psig at temperatures up to 650°F.

Copper-aluminum heating elements

Copper-aluminum heating elements shall consist of 0.016" thick, 1100 grade aluminum fins permanently bonded to lightly annealed copper alloy 122 seamless drawn tubing by mechanically expanding the copper tubing to the aluminum fins. Copper tube wall thickness; 3/4" dia - 0.020", 1" dia. - 0.025", 1-1/4" dia. - 0.028", prior to tube expansion. Copper tube meets the following ASTM standard designations: ASTM B42, ASTM B68, ASTM B75, ASTM B88, ASTM B111, ASTM B152, ASTM B280.

Guaranteed working pressures:

1-1/4" CU - 194 psig at temperatures up to 300°F. 1" CU - 204 psig at temperature up to 300°F. 3/4" CU - 218 psig at temperatures up to 300°F.

Mounting channel or full back panel:

Mounting channel shall be off-set from the wall and built from 20-gauge galvanized steel and the full back panel from 14-, 16- or 18-gauge galvanized steel (perforated enclosure) and 18- or 20-gauge galvanized steel (S-SL enclosure). For rigidity, the mounting channel or full back panel shall position the enclosure directly against the wall to limit access. A urethane gasket is available to form an air seal at the wall (optional for mounting channel).

Hanger brackets:

All hanger brackets shall be die formed for rigidity.

All hangers must provide for lengthwise movement of elements during expansion and contraction as well as aligning elements to prevent contact with brackets, walls, or enclosure.

Enclosures and accessories:

Enclosures shall be of the type as shown on the drawings. Enclosures shall be manufactured from 12-, 14-, or 16-gauge (perforated) or 14-, 16-, or 18-gauge (S-SL) cold rolled steel. All enclosures shall be reinforced with welded gussets. The joining of enclosure shall be accomplished by use of internal joggle joiners to provide for hairline joints and added rigidity.

Securing the top portion of the enclosure to the wall will be accomplished by use of a full length mounting channel or full back panel. The lower portion of the enclosure will be secured to the wall using security fasteners, which prevents removal without special tools (by others).

Damper:

Enclosure dampers shall be provided where indicated. Damper blades shall be fabricated from 18-gauge material painted to match enclosure color. Threaded damper screw and trunion shall provide positive operation of blade to provide variable heat output.

Security dampers available, to control airflow as required (operated by use of an allen key.) Knob damper only available with S-SL enclosure.

Mechanical specifications

Access doors

Access doors shall be provided where noted on plans. Doors shall be 6" x 6". Doors shall be hinged and have recessed security allen head operators. Doors shall be positioned directly in enclosure (or/in 12" long access panel). Consult factory on enclosure heights of 8" or below.

Paint:

All enclosures and accessories shall be degreased and chemically phosphatized before application of a durable, attractive, electrostatic epoxy powder coating. Decorator colors are available from Zehnder Rittling's color selector chart.

In the interest of product improvement, we reserve the right to make product and specification changes without notice.

Warranty

Zehnder Rittling guarantees its products to be free from defects in material and workmanship for a period of one year from date of shipment from our Buffalo, New York factory.

Should there be any defects in the good(s), the purchaser should promptly notify Zehnder Rittling and upon receipt of written consent from Zehnder Rittling, the purchaser shall return the defective good(s) to the factory for inspection with freight prepaid. If inspection shows the goods to be defective, Zehnder Rittling will at its discretion repair or replace the said item(s).

Defects arising from damage due to shipment, improper installation, negligence or misuse by others are not covered by this warranty.

This warranty is extended only to the original purchaser from Zehnder Rittling.

