

ENCLOSURES ARE AVAILABLE IN
1 FT. TO 8 FT. LENGTHS
IN 6 IN. INCREMENTS

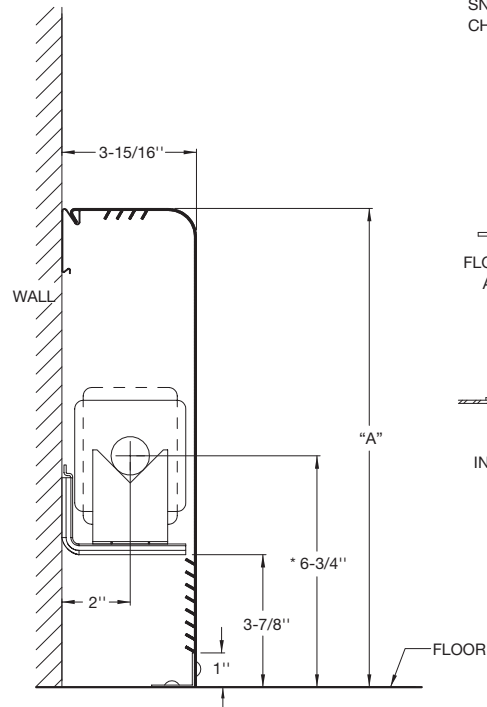

* CENTERLINES ARE BASED ON 1" COPPER TUBE

MODEL	PIPE SIZE		FIN SIZE	A
	STEEL	COPPER		
FTVL3	N/A	3/4", 1", 1-1/4"	2-3/4" x 4"	11"
	1", 1-1/4"	3/4", 1", 1-1/4"	3-1/4" x 3-1/4"	14"

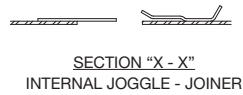
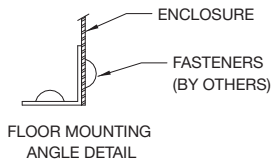
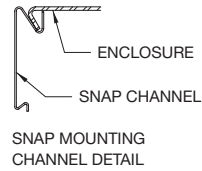
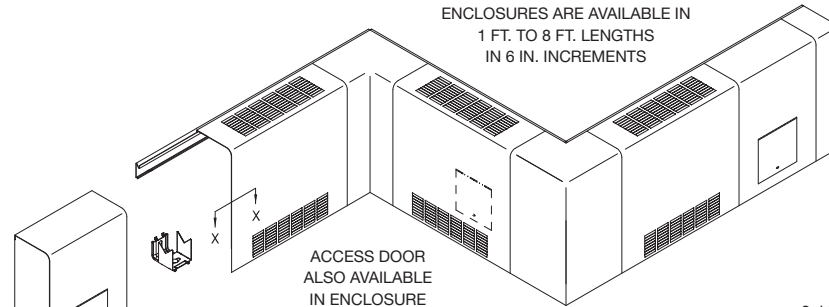

ACCESSORIES

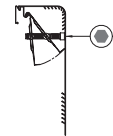
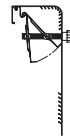
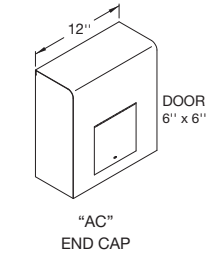
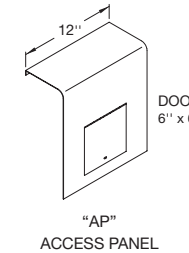
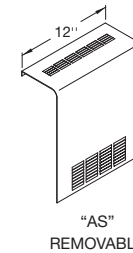
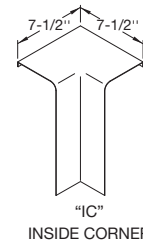
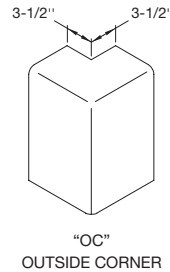
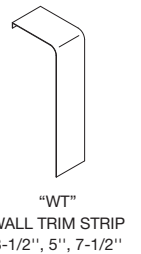
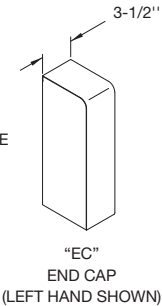
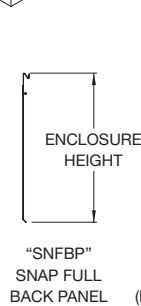
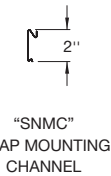

- NOTE:
1) ALL ACCESSORIES OVERLAP (EXCEPT AS NOTED)
2) BUTT TYPE (INTERLOCKING) STYLE OPTIONAL (EXCEPT AS NOTED)
3) CONSULT FACTORY ON DAMPER AVAILABILITY



CONTRACTOR _____ ELEMENT _____
 ARCHITECT _____ RATING _____ BTU _____ A.W.T. _____ E.A.T. _____
 ENGINEER _____ BACKPLATE _____ FULL _____ PARTIAL _____
 REPRESENTATIVE _____ ENCL. GAUGE _____ MATERIAL _____
 LOCATION _____ COLOR _____ DAMPER _____

ZEHNDER RITTLING
100 RITTLING BLVD. • BUFFALO, NY USA 14220

JOB:

ENCLOSURE MODEL: **FTVL3**

DATE: **January 2011**

DWG.NO.: **FTVL3**