

ENCLOSURES ARE AVAILABLE IN  
1 FT. TO 8 FT. LENGTHS  
IN 6 IN. INCREMENTS

ACCESS DOOR  
ALSO AVAILABLE  
IN ENCLOSURE

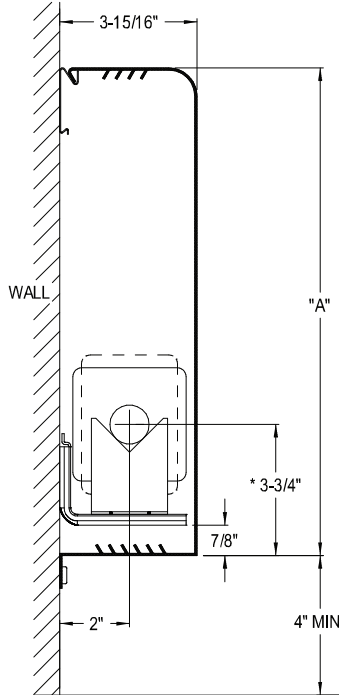

\*CENTERLINES ARE BASED ON 1" COPPER TUBE

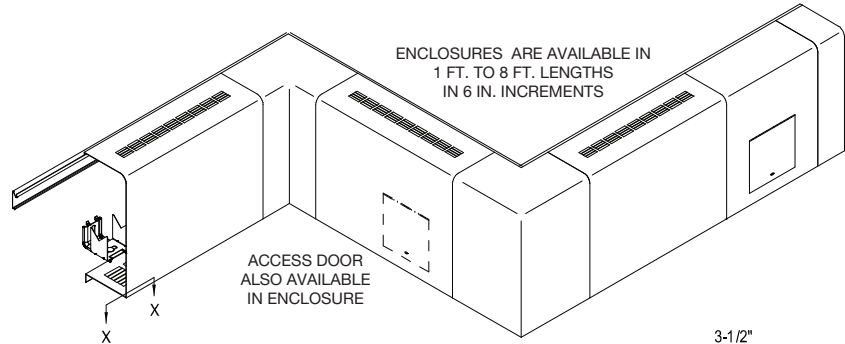
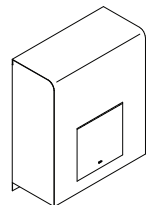
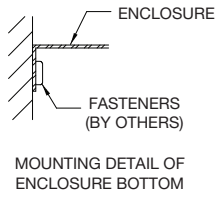
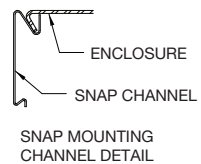

## ACCESSORIES

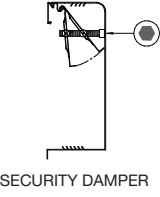
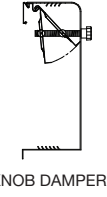
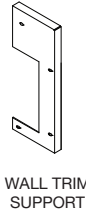
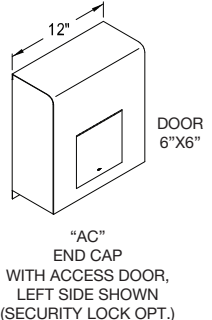
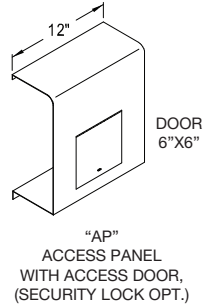
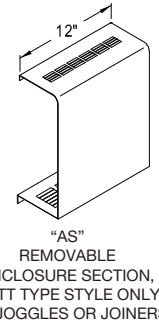
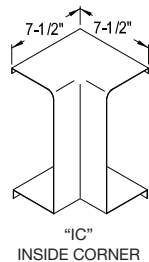
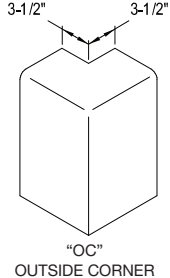
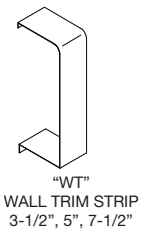
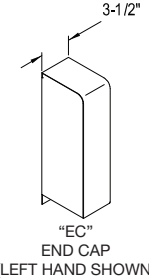
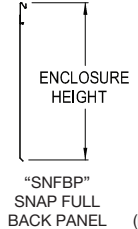
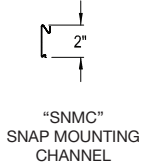

NOTE:  
1) ALL ACCESSORIES OVERLAP (EXCEPT AS NOTED)  
2) BUTT TYPE (INTERLOCKING) STYLE OPTIONAL (EXCEPT AS NOTED)



MODEL	PIPE SIZE		FIN SIZE	A
	STEEL	COPPER		
FTHL3	N/A	3/4", 1", 1-1/4"	2-3/4" x 4"	8"
	1", 1-1/4"	3/4", 1", 1-1/4"	3-1/4" x 3-1/4"	11"
				14"

CONTRACTOR \_\_\_\_\_ ELEMENT \_\_\_\_\_  
 ARCHITECT \_\_\_\_\_ RATING \_\_\_\_\_ BTU \_\_\_\_\_ A.W.T. \_\_\_\_\_ E.A.T. \_\_\_\_\_  
 ENGINEER \_\_\_\_\_ BACKPLATE \_\_\_\_\_ FULL \_\_\_\_\_ PARTIAL \_\_\_\_\_  
 REPRESENTATIVE \_\_\_\_\_ ENCL. GAUGE \_\_\_\_\_ MATERIAL \_\_\_\_\_  
 LOCATION \_\_\_\_\_ COLOR \_\_\_\_\_ DAMPER \_\_\_\_\_

ZEHNDER RITTLING  
100 RITTLING BLVD. • BUFFALO, NY USA 14220

JOB: \_\_\_\_\_

ENCLOSURE MODEL: **FTHL3**

DATE: **October 2015** DWG.NO.: **FTHL3**