

ENCLOSURES ARE AVAILABLE IN
1 FT. TO 8 FT. LENGTHS
IN 6 IN. INCREMENTS

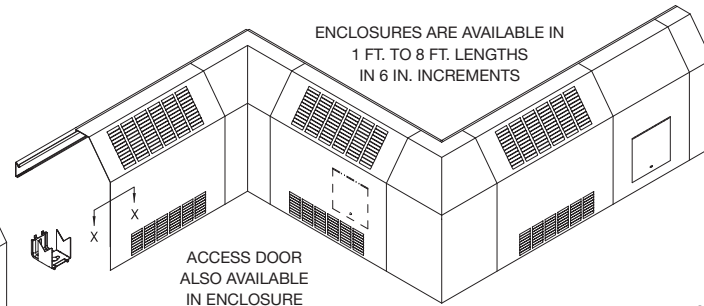

ACCESSORIES

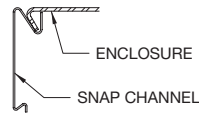

SNAP MOUNTING
CHANNEL DETAIL

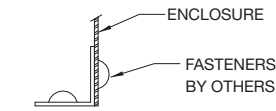

FLOOR MOUNTING
ANGLE DETAIL

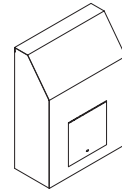

"SNMC"
SNAP MOUNTING
CHANNEL



"SLSRB"
SLIP - IN SECOND
ROW BRACKET



"WPH"
WALL PIPE
HANGER

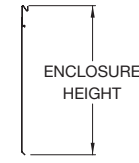

"SNFBP"
SNAP FULL
BACK PANEL

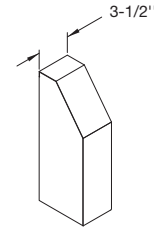

"EC"
END CAP
(LEFT HAND SHOWN)



"WT"
WALL TRIM STRIP
3-1/2", 5", 7-1/2"

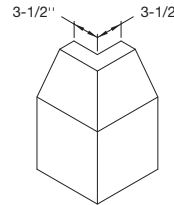

"OC"
OUTSIDE CORNER

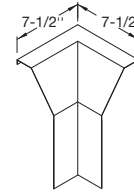

"IC"
INSIDE CORNER

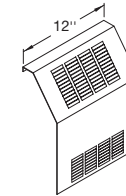

"AS"
REMOVABLE
ENCLOSURE SECTION
BUTT TYPE STYLE ONLY
NO JOGGLES OR JOINERS

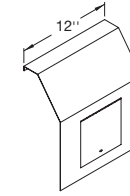

"AP"
ACCESS PANEL
WITH ACCESS DOOR,
(SECURITY LOCK OPT.)

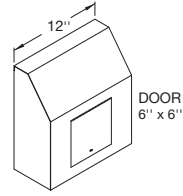

"AC"
END CAP
WITH ACCESS DOOR,
LEFT SIDE SHOWN
(SECURITY LOCK OPT.)

NOTE:
1) ALL ACCESSORIES OVERLAP
(EXCEPT AS NOTED)
2) BUTT TYPE (INTERLOCKING) STYLE OPTIONAL
(EXCEPT AS NOTED)
3) CONSULT FACTORY ON DAMPER AVAILABILITY



"WS"
WALL TRIM SUPPORT



KNOB DAMPER

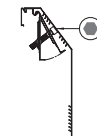

SECURITY DAMPER

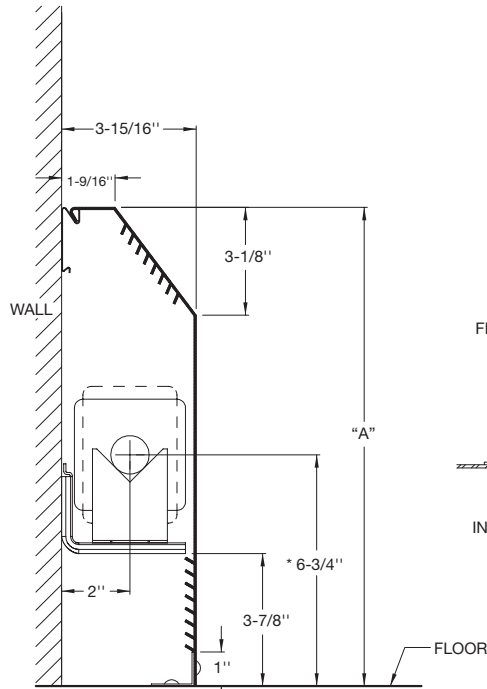

* CENTERLINES ARE BASED ON 1" COPPER TUBE

MODEL	PIPE SIZE		FIN SIZE	A
	STEEL	COPPER		
FVL3	N/A	3/4", 1", 1-1/4"	2-3/4" x 4"	14"
	1", 1-1/4"	3/4", 1", 1-1/4"	3-1/4" x 3-1/4"	



CONTRACTOR _____ ELEMENT _____

ARCHITECT _____ RATING _____ BTU _____ A.W.T. _____ E.A.T. _____

ENGINEER _____ BACKPLATE _____ FULL _____ PARTIAL _____

REPRESENTATIVE _____ ENCL. GAUGE _____ MATERIAL _____

LOCATION _____ COLOR _____ DAMPER _____

ZEHNDER RITTLING
100 RITTLING BLVD. • BUFFALO, NY USA 14220

JOB:

ENCLOSURE MODEL: **FVL3**

DATE: **January 2011**

DWG.NO.: **FVL3**