

ENCLOSURES ARE AVAILABLE IN
1 FT. TO 8 FT. LENGTHS
IN 6 IN. INCREMENTS

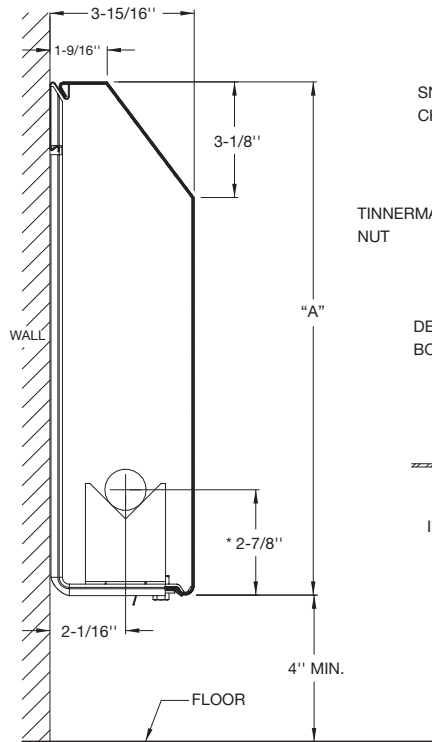

* CENTERLINES ARE BASED ON 1" COPPER TUBE

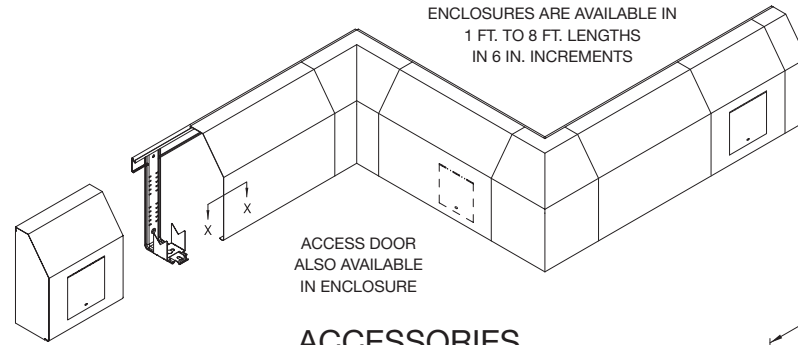
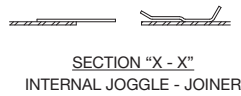
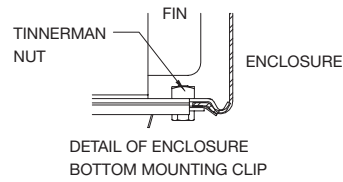
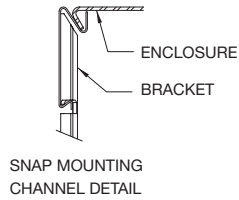

ACCESSORIES

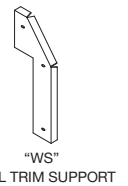
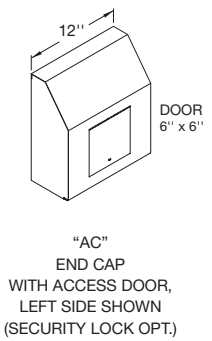
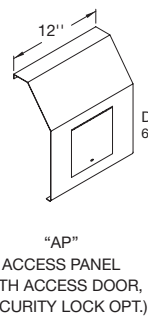
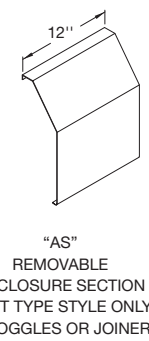
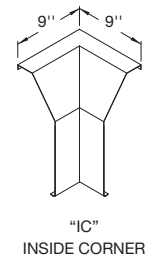
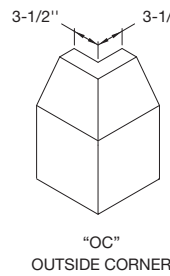
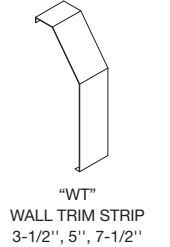
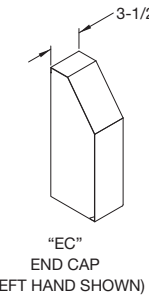
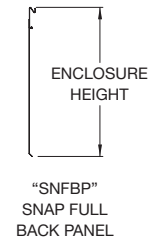
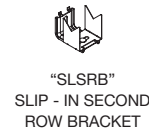
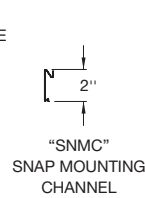

NOTE:
1) ALL ACCESSORIES OVERLAP (EXCEPT AS NOTED)
2) BUTT TYPE (INTERLOCKING) STYLE OPTIONAL (EXCEPT AS NOTED)



CONTRACTOR _____ ELEMENT _____

ARCHITECT _____ RATING _____ BTU _____ A.W.T. _____ E.A.T. _____

ENGINEER _____ BACKPLATE _____ FULL _____ PARTIAL _____

REPRESENTATIVE _____ ENCL. GAUGE _____ MATERIAL _____

LOCATION _____ COLOR _____ DAMPER _____

ZEHNDER RITTLING
100 RITTLING BLVD. • BUFFALO, NY USA 14220

JOB: _____

ENCLOSURE MODEL: **FSN3**

DATE: **May 2011** DWG.NO.: **FSN3**