

zehnder Rittling

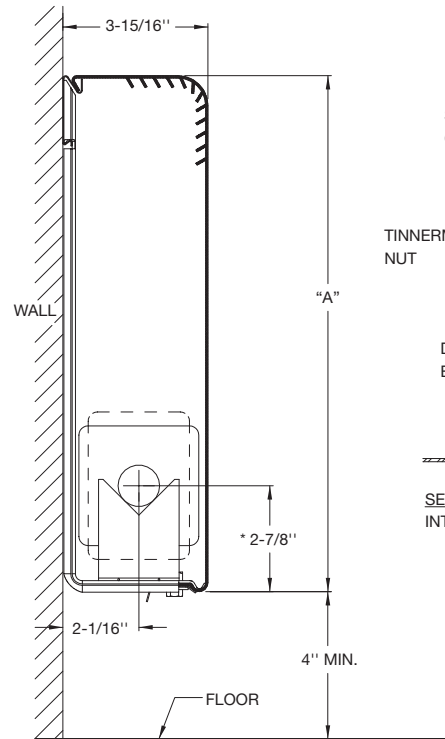

* CENTERLINES BASED ON 1" COPPER TUBE

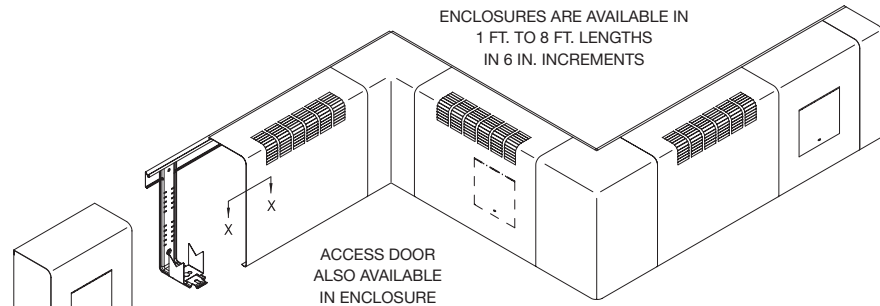
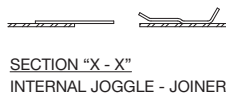
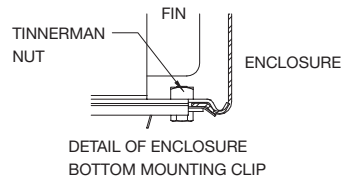
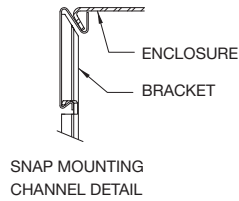

ACCESSORIES

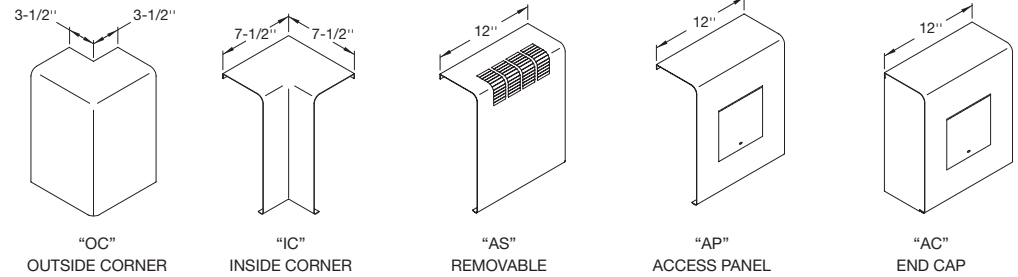
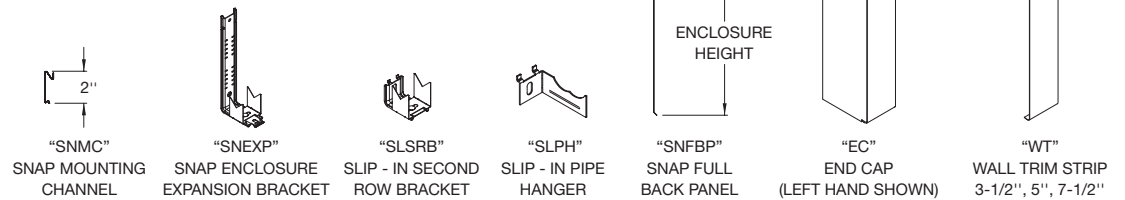

NOTE:
 1) ALL ACCESSORIES OVERLAP (EXCEPT AS NOTED)
 2) BUTT TYPE (INTERLOCKING) STYLE OPTIONAL (EXCEPT AS NOTED)



MODEL	PIPE SIZE		FIN SIZE	A
	STEEL	COPPER		
FR3	N/A	3/4", 1", 1-1/4"	2-3/4" x 4"	8"
	1", 1-1/4"	3/4", 1", 1-1/4"	3-1/4" x 3-1/4"	11"
				14"

CONTRACTOR _____ ELEMENT _____

ARCHITECT _____ RATING _____ BTU _____ A.W.T. _____ E.A.T. _____

ENGINEER _____ BACKPLATE _____ FULL _____ PARTIAL _____

REPRESENTATIVE _____ ENCL. GAUGE _____ MATERIAL _____

LOCATION _____ COLOR _____ DAMPER _____

ZEHNDER RITTLING
 100 RITTLING BLVD. • BUFFALO, NY USA 14220

JOB:

ENCLOSURE MODEL: **FR3**

DATE: **January 2011**

DWG.NO.: **FR3**