

# zehnder Rittling

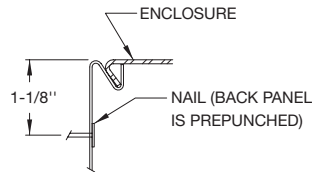

**BACK PANEL DETAIL**

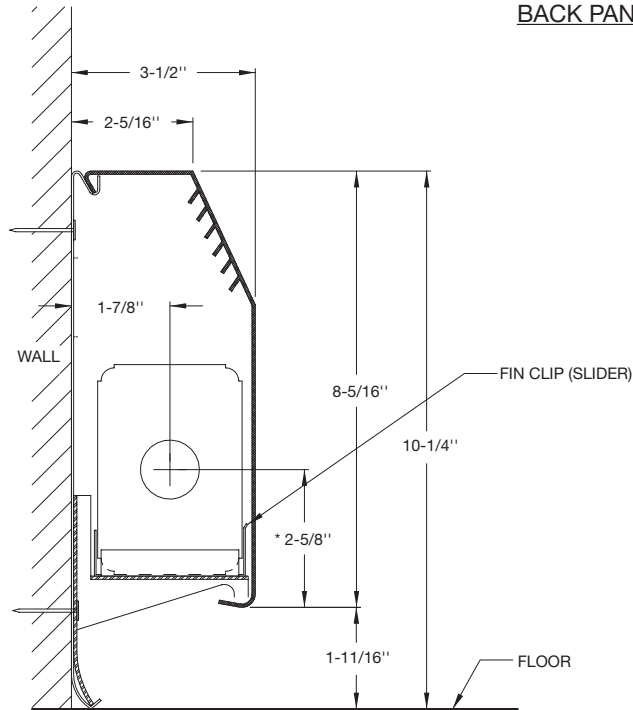

\* CENTERLINES BASED ON 1" COPPER TUBE

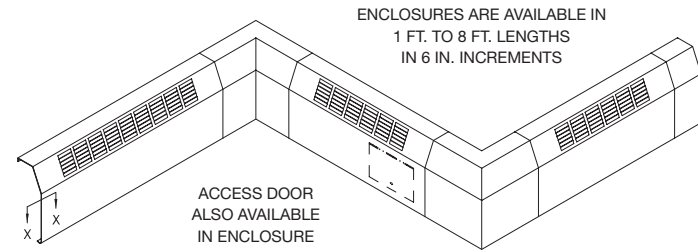

## ACCESSORIES

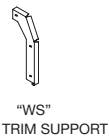
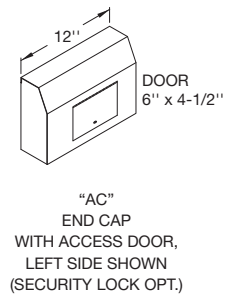
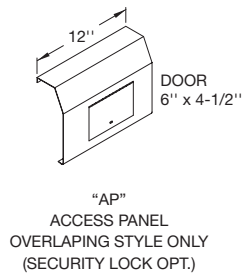
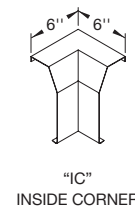
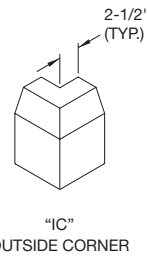
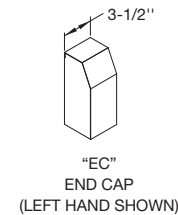
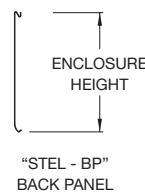

**NOTE:**

- 1) ALL ACCESSORIES OVERLAP (EXCEPT AS NOTED)
- 2) INTERLOCKING STYLE OPTIONAL (EXCEPT AS NOTED)
- 3) ALL ENCLOSURES AND ACCESSORIES ARE WITHOUT JOGGLES AND JOINERS



MODEL	PIPE SIZE	FIN SIZE
	COPPER	
STEL	3/4", 1", 1-1/4"	2-3/4" x 4"

CONTRACTOR \_\_\_\_\_ ELEMENT \_\_\_\_\_  
 ARCHITECT \_\_\_\_\_ RATING \_\_\_\_\_ BTU \_\_\_\_\_ A.W.T. \_\_\_\_\_ E.A.T. \_\_\_\_\_  
 ENGINEER \_\_\_\_\_ BACKPLATE \_\_\_\_\_ FULL \_\_\_\_\_ PARTIAL \_\_\_\_\_  
 REPRESENTATIVE \_\_\_\_\_ ENCL. GAUGE \_\_\_\_\_ MATERIAL \_\_\_\_\_  
 LOCATION \_\_\_\_\_ COLOR \_\_\_\_\_ DAMPER \_\_\_\_\_

ZEHNDER RITTLING  
100 RITTLING BLVD. • BUFFALO, NY USA 14220

JOB:

ENCLOSURE MODEL: **STEL**

DATE: **January 2011**

DWG.NO.: **STEL**