

zehnder Rittling

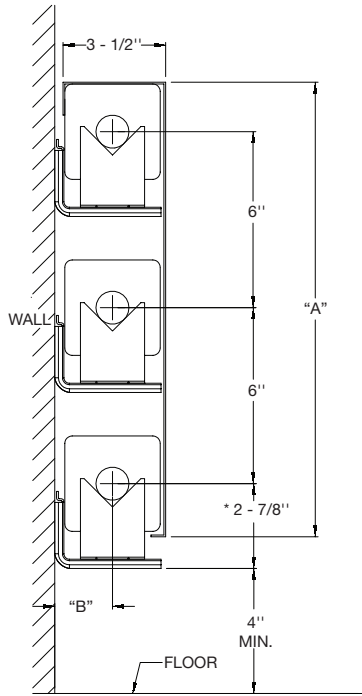

* CENTERLINES ARE BASED ON 1" COPPER TUBE

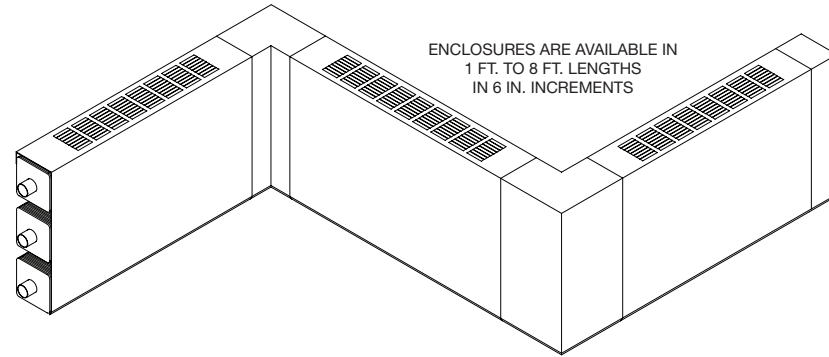

ACCESSORIES



SLIP - IN SECOND ROW BRACKET

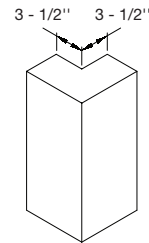

"OC" OUTSIDE CORNER

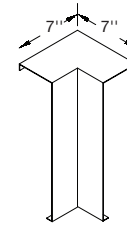

"IC" INSIDE CORNER

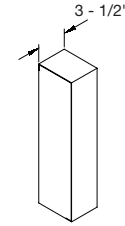

"EC" END CAP (LEFT HAND SHOWN)



"WT" WALL TRIM STRIP 3 - 1/2", 5", 7 - 1/2"

MODEL	PIPE SIZE		FIN SIZE	A	B
	STEEL	COPPER			
ETO	1 - 1/4" - 2"	1", 1 - 1/4"	3 - 1/4" x 3 - 1/4"	3 - 5/8" 9 - 5/8" 15 - 5/8"	1 - 31/32"

* ALL ACCESSORIES OVERLAP
** BUTT - TYPE OPTIONAL



CONTRACTOR _____ ELEMENT _____

ARCHITECT _____ RATING _____ BTU _____ A.W.T. _____ E.A.T. _____

ENGINEER _____ BACKPLATE _____ FULL _____ PARTIAL _____

REPRESENTATIVE _____ ENCL. GAUGE _____ MATERIAL _____

LOCATION _____ COLOR _____ DAMPER _____

ZEHNDER RITTLING
100 RITTLING BLVD. • BUFFALO, NY USA 14220

JOB:

ENCLOSURE MODEL: **ETO3**

DATE: **January 2011**

DWG.NO.: **ETO3**