

ENCLOSURES ARE AVAILABLE IN  
1 FT. TO 8 FT. LENGTHS  
IN 6 IN. INCREMENTS

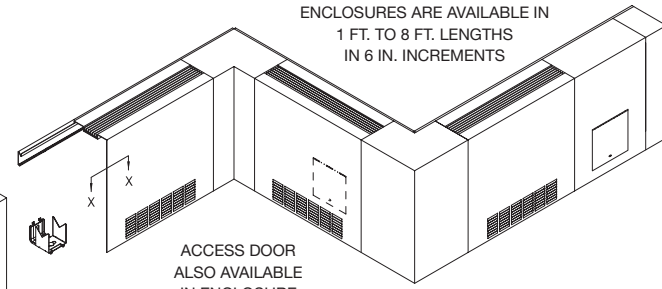

ACCESS DOOR  
ALSO AVAILABLE  
IN ENCLOSURE

## ACCESSORIES

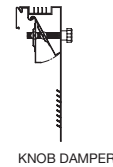
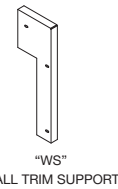
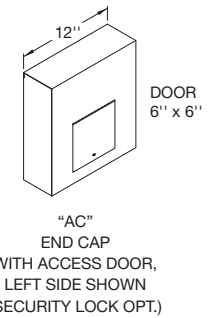
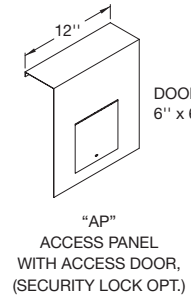
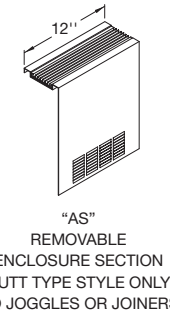
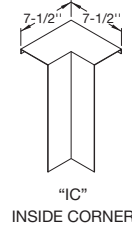
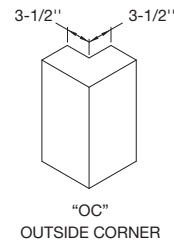
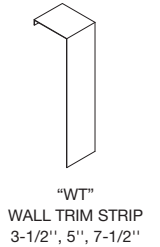
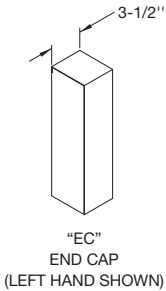
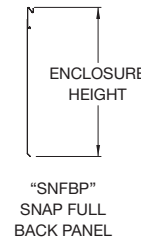
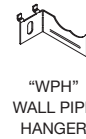
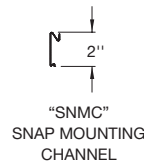
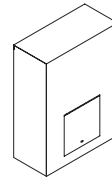
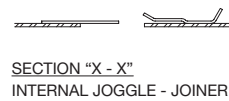
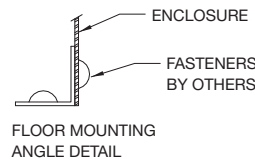
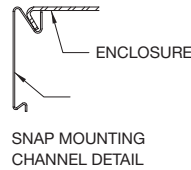
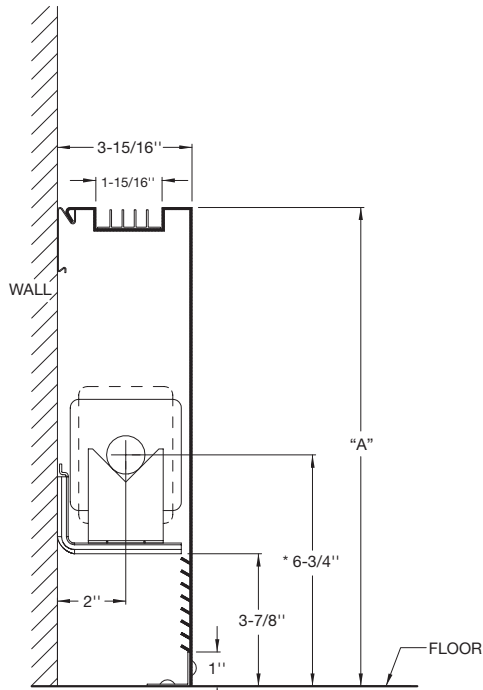

NOTE:  
1) ALL ACCESSORIES OVERLAP  
(EXCEPT AS NOTED)  
2) BUTT TYPE (INTERLOCKING) STYLE OPTIONAL  
(EXCEPT AS NOTED)  
3) CONSULT FACTORY ON DAMPER AVAILABILITY



MODEL	PIPE SIZE		FIN SIZE	A
	STEEL	COPPER		
BGVL3	N/A	3/4", 1", 1-1/4"	2-3/4" x 4"	11"
	1", 1-1/4"	3/4", 1", 1-1/4"	3-1/4" x 3-1/4"	14"

CONTRACTOR \_\_\_\_\_ ELEMENT \_\_\_\_\_

ARCHITECT \_\_\_\_\_ RATING \_\_\_\_\_ BTU \_\_\_\_\_ A.W.T. \_\_\_\_\_ E.A.T. \_\_\_\_\_

ENGINEER \_\_\_\_\_ BACKPLATE \_\_\_\_\_ FULL \_\_\_\_\_ PARTIAL \_\_\_\_\_

REPRESENTATIVE \_\_\_\_\_ ENCL. GAUGE \_\_\_\_\_ MATERIAL \_\_\_\_\_

LOCATION \_\_\_\_\_ COLOR \_\_\_\_\_ DAMPER \_\_\_\_\_

ZEHNDER RITTLING  
100 RITTLING BLVD. • BUFFALO, NY USA 14220

JOB:

ENCLOSURE MODEL: **BGVL3**

DATE: **January 2011**

DWG.NO.: **BGVL3**